

Controllers for Multiplexed Cabinets XM679K Rel. 5.4

Installing and Operating Instructions

1 Introduction

1.1. General Warning

Please read the following safety precautions and warnings before using this manual:



CAUTION!

- This manual is part of the product and should be kept near the device for easy and quick reference.
- The device should not be used for purposes different from those described in this manual. It cannot be used as a safety device.
- Check the application limits before proceeding.
- Emerson reserves the right to change the composition of its products, even without notice, ensuring the same and unchanged functionality.



SAFETY PRECAUTIONS!

- Check that the supply voltage is correct before connecting the device.
- Do not expose to water or moisture: use the controller only within the operating limits and avoid sudden temperature changes with high atmospheric humidity to prevent condensation from forming.
- Warning: Disconnect all electrical connections before performing any kind of maintenance.
- Fit the probe where it is not accessible by the end user. The device must not be opened.
- In case of failure or faulty operation, send the device back to the distributor or to Emerson Retail Solutions (see address) with a detailed description of the fault.
- Verify the maximum current that can be applied to each relay (see Section 19, Technical Data).
- Ensure that the wires for probes, loads, and the power supply are separated and far enough from each other without crossing or intertwining.
- In case of applications in industrial environments, the use of main filters in parallel with inductive loads could be useful.

2 Before Proceeding

2.1. Software Release of XM679K

1. Look at the software release of XM679K printed on the label of the controller.

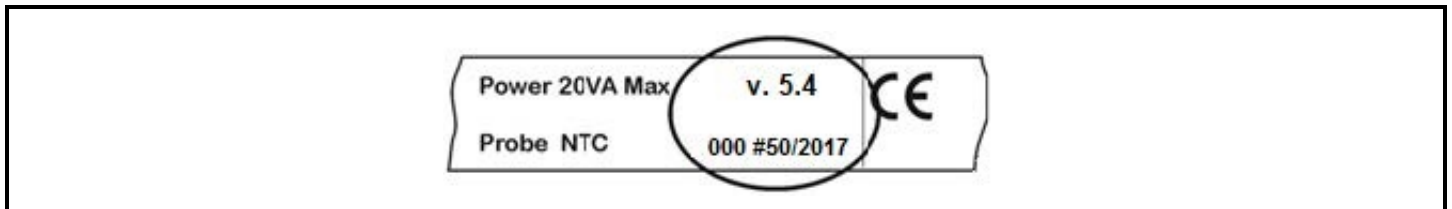

Figure 2-1 - Software Release of XM679K 5.4

2. If the software release is 5.4, proceed with this manual; otherwise contact Emerson to access the correct manual.
3. Note that RTC is not supported on devices connected to E2, E3, and Site Supervisor.

3 General Description

The **XM679K** is a high level microprocessor based controllers for multiplexed cabinets suitable for applications on medium or low temperature. The XM679K can be inserted in a LAN of up to eight (8) different sections which can operate, depending on the programming, as a stand alone controller or following the commands coming from the other sections. The XM679K is provided with six (6) relay outputs to control the solenoid valve, defrost that can be either electrical or hot gas, evaporator fans, the lights, an auxiliary output (XM679K) and an alarm output (XM679K) and with one output to drive **pulsed electronic expansion valves**. The XM679K is also provided with four probe inputs, one for temperature control, one to control the defrost end temperature of the evaporator, the third for the display and the fourth can be used for application with virtual probe or for inlet/outlet air temperature measurement. They are provided by other two probes that have to be used for superheat measurement and regulation. Finally, the XM679K is equipped with the three digital inputs (free contact), fully configurable by parameters.

The Hotkey connector allows simple programming of the controller. The optional direct serial output **RS485** that is **MODBUS-RTU** compatible permits simple XWEB interfacing. Depending on the model, the Hotkey connector can be used to connect the **X-REP** display.

3.1. Ordering Codes

Part Number	Description
318-6521	XM670K Case Controller Solenoid, 110V, V5.4, NTC CPC, with Connectors
318-6702	XM679K Case Controller Pulse Control, 110V, V5.4, CPC+4.20, with Connectors
318-6750	Remote Display Keyboard CX660 for XMs
318-6751	Remote Display Keyboard CH660 for XMs

Table 3-1 - Product Ordering Codes

4 Installation and Mounting

This device can operate without any user interface, but normal application is with CX660 or CH660 keyboard (both 660 displays are supported).

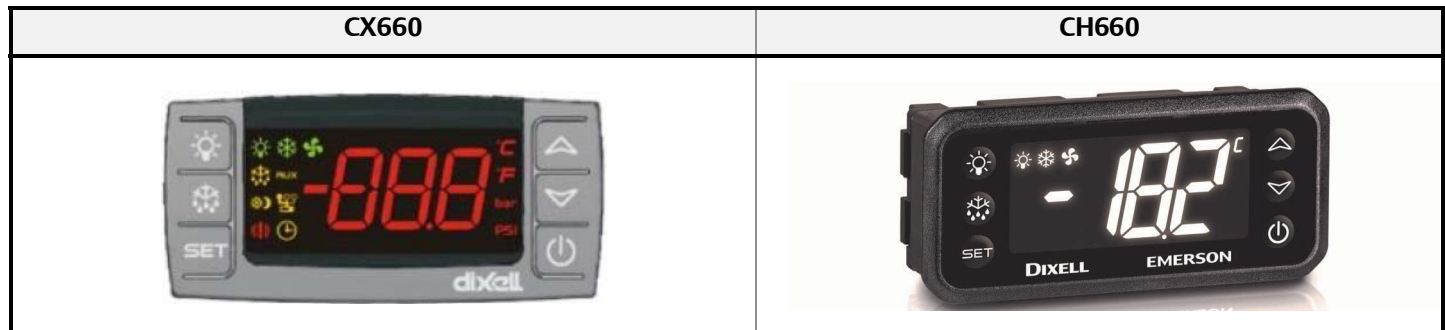

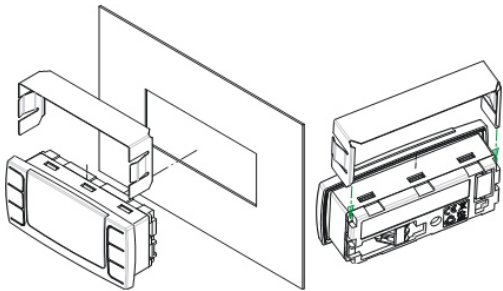

The **CX660 keyboard** should be mounted on a vertical panel, in a 29 x 71 mm hole, and secured using the special bracket supplied **Figure 4-1**

The temperature range allowed for correct operation is 32 to 140°F (0 to 60°C). Avoid places subject to strong vibrations, corrosive gases, excessive dirt or humidity. The same recommendations apply to probes. Allow air to circulate through the cooling holes.

Figure 4-1 - CX660 Keyboard Installation and Mounting

4.1. Dimensions

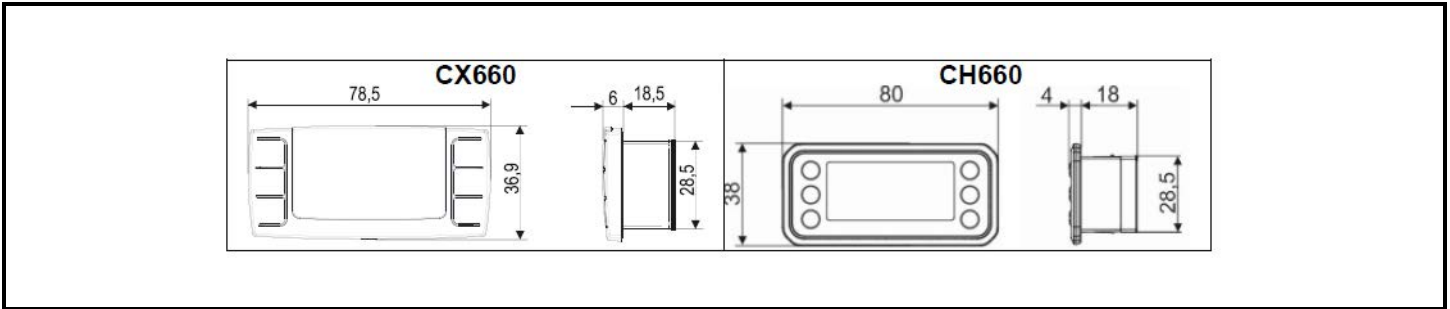

Figure 4-2 - CX660 and CH660 Dimensions

5 Wiring Diagram and Connections

5.1. Important Note

The **XM** device is provided with a disconnectable terminal block to connect cables with a cross-section of up to 1.6 mm² for all low voltage connections: RS485, LAN, probes, digital inputs, and keyboard. Other inputs, power supply and relay connections are provided with a screw terminal block or Faston connection (5.0 mm). Heat-resistant cables have to be used. Before connecting the cables, verify that the power supply complies with the controller's requirements. Separate the probe cables from the power supply cables, outputs and power connections. Do not exceed the maximum current allowed on each relay. In case of heavier loads, use a suitable external relay. *N.B Maximum current allowed for all loads is 16A.*

The probes should be mounted with the bulb upwards to prevent damages due to casual liquid infiltration. It is recommended to place the thermostat probe away from air streams to measure the average room temperature correctly. Place the defrost termination probe among the evaporator fans in the coldest place (where most ice is formed) and far from heaters or from the warmest place during defrost to prevent premature defrost termination.

NOTE: The jumper indicated as *JMP* is inside the case of the controller **PLEASE DISCONNECT THE POWER SUPPLY BEFORE MOVING IT.** This jumper must be closed only in case of driving 24Vac valve.

5.2. XM679K- 230VAC Valves

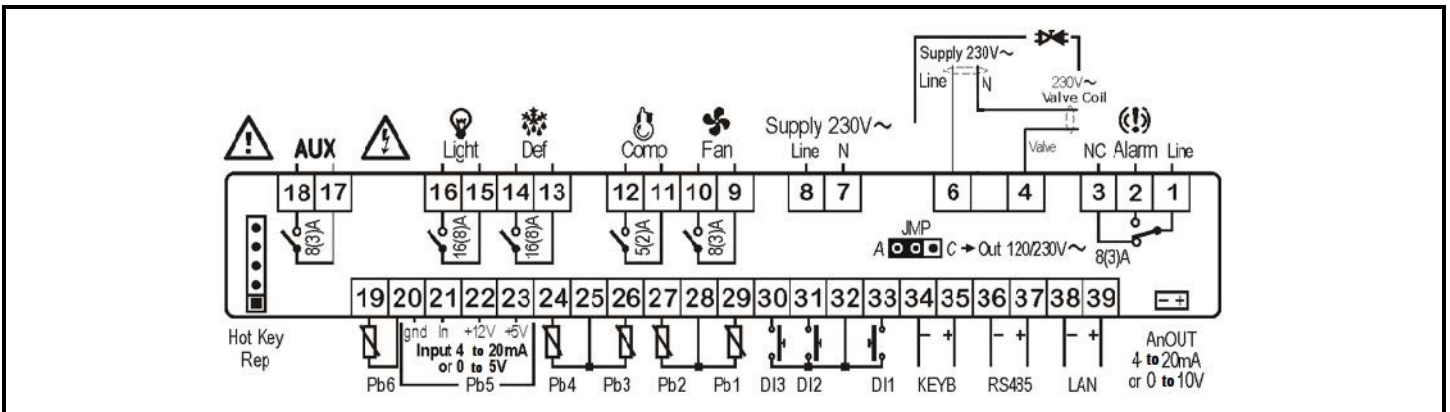

Figure 5-1 - Wiring and Connections

Models with 115V supply: use terminals 8-7 for supply.

5.3. XM679K- 24VAC Valves

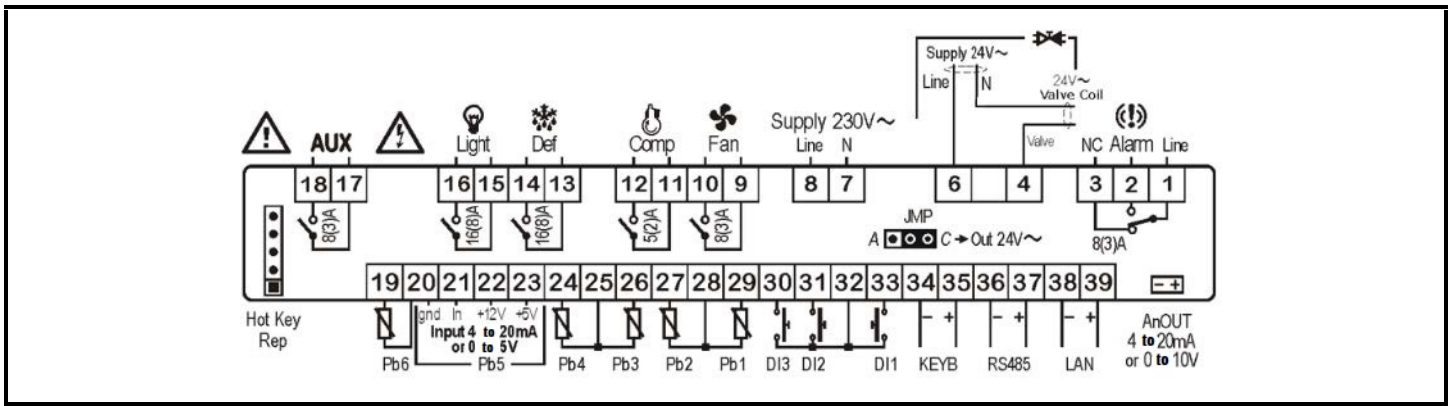

Figure 5-2 - Wiring and Connections

Models with 115V supply: use terminals 8-7 for supply

NOTE: The jumper indicated as JMP is inside the case of the controller. This jumper must be closed only in case of driving 24Vac valve.

5.4. Keyboard Display CX660

The XM670/679K Board can operate also without keyboard.

Polarity:
Terminal [34] [-]
Terminal [35] [+]

Use twister shielded cable AWG 18 or less in case of long distance.

Max distance: 30 meters

Figure 5-3 - Keyboard Display

5.5. LAN Connection

To create a LAN connection and to perform synchronized defrost (also called master-slave functioning):

1. Connect a shielded cable between terminals 38 [-] and 39 [+] for a maximum of eight (8) sections.
2. The **Adr** parameter is the number that identifies each electronic board. *Address duplication is not permitted*; in this case, synchronized defrost and the communication with the monitoring system are not guaranteed (the **Adr** is also the MODBUS address). See **Figure 5-4** for an example of a properly configured LAN connection:

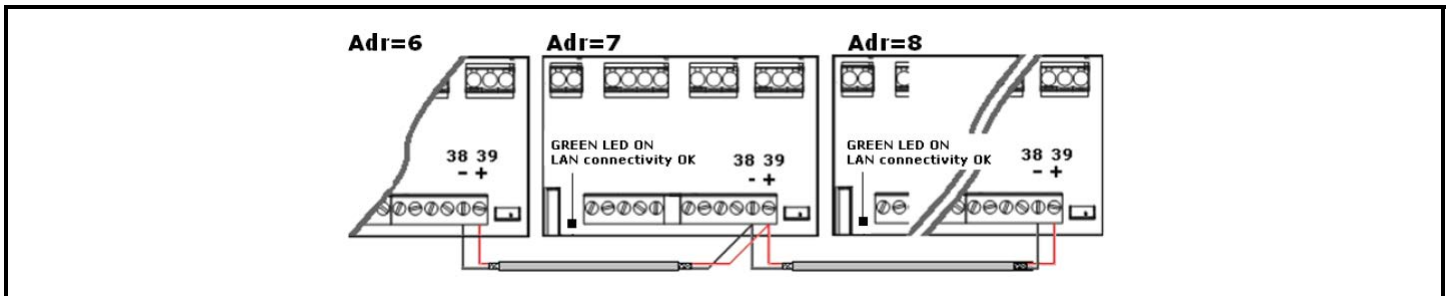
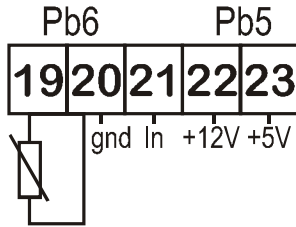

Figure 5-4 - LAN Connection



NOTE: If the LAN is connected properly, the green LED will be ON. If the LAN is not connected properly, a blinking LED will display. The maximum allowed distance is 30 meters.

5.6. Sensors for Superheat Control - Only for XM679K



Temperature probe: Pb6 Terminals 19-20 without any polarity.

Select the kind of sensor with the **P6C** parameter.

Pressure transducer: Pb5 Terminals

[21] = signal input

[22] = power supply for 4 to 20mA transducer

[20] = GND

[23] = +5VDC power supply for ratiometric pressure transducer

Select the transducer configuration with the **P5C** parameter.

Figure 5-5 - Sensors for Superheat Control

5.7. How to Use a Single Pressure Transducer on Multiplexed Applications

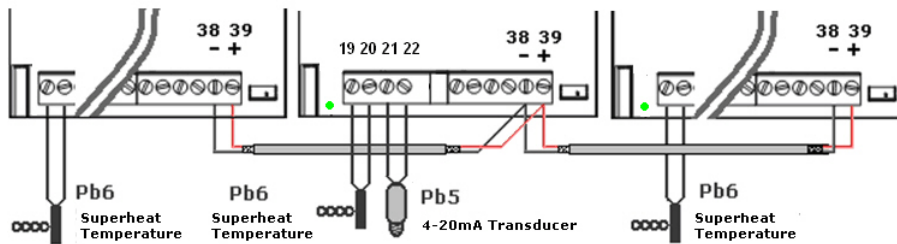

Figure 5-6 - Pressure Transducer on Multiplexed Applications

A working LAN connection is required (green LED illuminated on all XM670- XM679K boards of the same LAN). Connect and configure the pressure transducer only on **one** XM670- XM679K of the network. Afterwards, the pressure value read by that single transducer will be used by each device connected to the same LAN.

To read the pressure value, press the **up arrow** button to access the fast selection menu and read the value of the following parameters:

- **dPP** - Measured pressure (only on the master device)
- **dP5** - Temperature value obtained from the pressure value (temperature conversion)
- **rPP** - Pressure value read from remote location (only for slave devices)

Examples of error messages:

- **dPP = Err** - The local transducer read an incorrect value; the pressure value is out of range of the pressure transducer or the **P5C** parameter is incorrect. Check if any of the above causes the error, otherwise replace the transducer.
- **rPF** - There is an error in the remote pressure transducer. Check the status of the board (GREEN LED); if the LED is OFF, then the LAN is not functioning, otherwise, check the remote pressure transducer.

Last Checks about the Superheat:

On the fast access menu:

- **dPP** - The value read by the gauge.
- **dP6** - The value read by the temperature probe, the temperature of the gas on the evaporator outlet.
- **SH** - The value of the superheat. The **nA** or **Err** message means that the superheat cannot be read at the moment and the value is not available.

5.8. How to Connect the Monitoring System

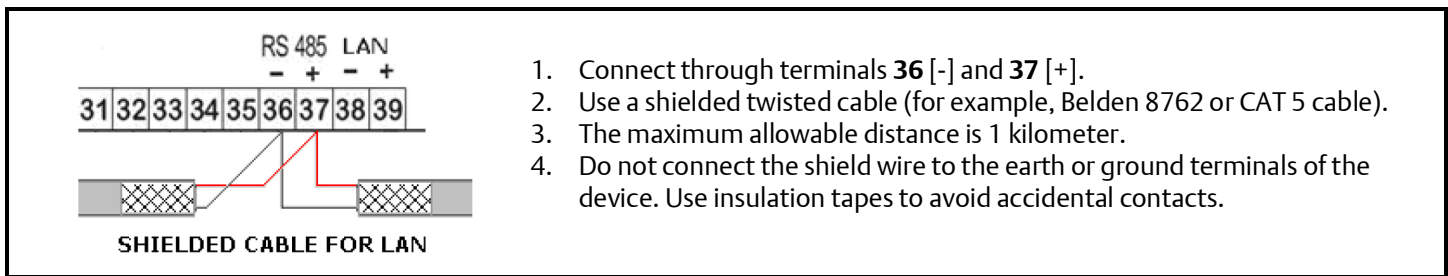

Figure 5-7 - Connecting the Monitoring System

Only one controller for each LAN should be connected to the RS485 connection.

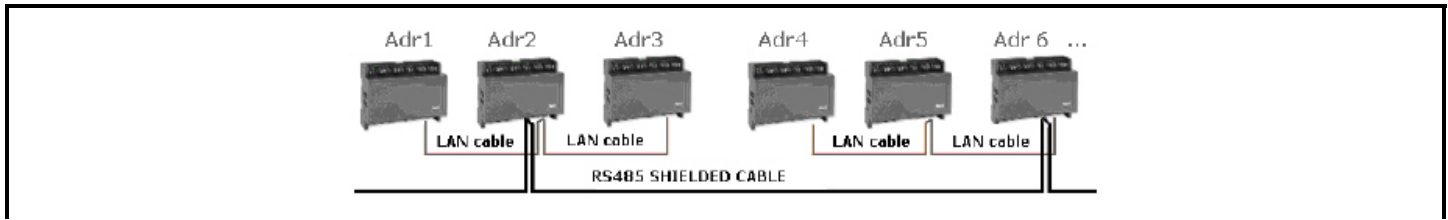

Figure 5-8 - Connecting Monitoring Systems

The **Adr** parameter is the number that identifies each electronic board. **Address duplication is not permitted**; in this case, synchronized defrost and the communication with the monitoring system are not guaranteed (the **Adr** is also the MODBUS address).

5.9. Digital Inputs

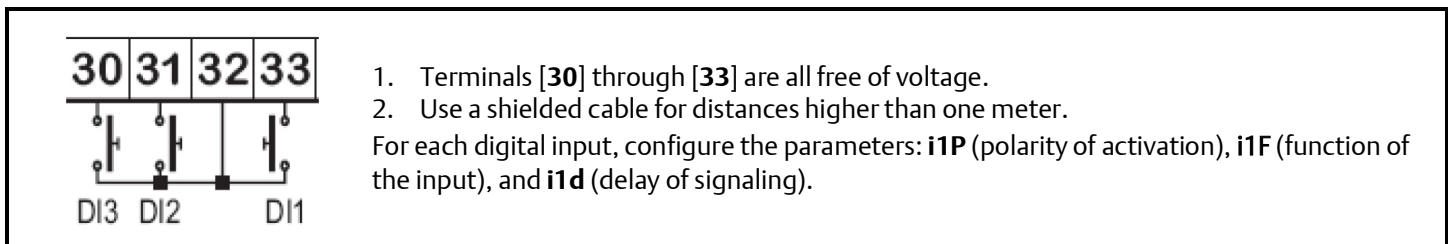

Figure 5-9 - Digital Inputs

The **i1P** can be set to: **cL**= active when closed; or **oP**= active when opened.

The **i1F** parameter can be set to: **EAL** = external alarm, **Bal** = serious lock alarm, **PAL**= pressure switch alarm, **dor** = door switch, **dE F**= external defrost, **AUS**= auxiliary activation command, **LiG**= light activation, **OnF** = board On/OFF, **FHU**= do not use this configuration, **ES**= day/night, or **HdY** = do not use this configuration.

The **i1d** parameter is for the delay of activation.

For the other digital inputs, same set of parameters is present: **i2P**, **i2F**, **i2d**, **i3P**, **i3F**, **i3d**.

5.10. Analog Output

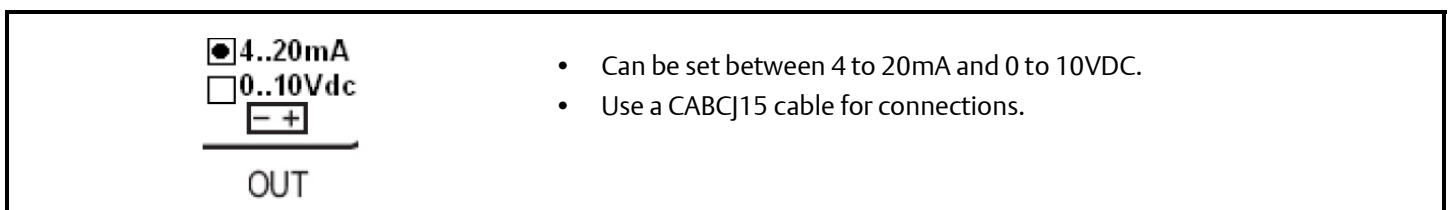

Figure 5-10 - Analog Output

The analog output is located near the terminal [39] on a two-pin connector. The analog output can be used to control anti-sweat heaters using a chopped phased controller, XRPW500 (500 watt) or family, XV...D or XV...K.

6 Quick Reference Guide in Running the Self Adaptive Regulation

1. After wiring the XM679K; **set the proper gas via Fty parameter.**
2. **Set the proper gas via Fty parameter.** Preset gas is **R404A.**



NOTE: Check the pressure gauge reading with the value of dPP. Press the up arrow once to enter the Fast Access Menu. If OK, proceed; otherwise resolve the situation before acting on the parameter.

LABEL	REFRIGERANT	OPERATING RANGE
R22	r22	-58 to 120°F / -50 to 60°C
134	r134A	-58 to 120°F / -50 to 60°C
290	r290 – Propane	-58 to 120°F / -50 to 60°C
404	r404A	-94 to 120°F / -70 to 60°C
47A	r407A	-58 to 120°F / -50 to 60°C
47C	r407C	-58 to 120°F / -50 to 60°C
47F	r407F	-58 to 120°F / -50 to 60°C
410	r410A	-58 to 120°F / -50 to 60°C
448	r448A	-49 to 120°F / -45 to 60°C
449	r449A	-49 to 120°F / -45 to 60°C
450	r450A	-49 to 120°F / -45 to 60°C
452	r452A	-94 to 120°F / -70 to 60°C
507	r507	-94 to 120°F / -70 to 60°C
513	r513A	-49 to 120°F / -45 to 60°C
CO2	r744 - Co2	-58 to 77°F / -50 to 25°C
15b	r515b	-22 to 120°F / -30 to 60°C
54A	r454A	-58 to 120°F / -50 to 60°C
54b	r454B	-58 to 120°F / -50 to 60°C
54C	r454C	-58 to 120°F / -50 to 60°C
55A	r455A	-40 to 120°F / -40 to 60°C
4yF	r1234yf	-58 to 120°F / -50 to 60°C
4EE	r1234ze	-58 to 120°F / -50 to 60°C

Table 6-1 - XM679K Gas Table

3. Configure the probes:

- **Regulation and evaporator probes** are preset as NTC. If another kind of sensors is used, it can be set to P1c and P2c parameters.
- **Superheat evaporator outlet probe** is preset as Pt1000, if another kind of sensor is used, it can be set to P6c parameter.
- The **PP11** (-0.5 to 11 bar) is preset as **pressure probe**. It operates at relative pressure (Pru = rE). If you are using a ratio-metric transducer, set **P5c = 0-5**. Use parameters **PA4** and **P20** to set the range.

4. Set the parameters for self adaptive regulation of superheat.



NOTE: The parameters Pb (regulation band) and Int (integral time) are automatically calculated by the controller.

- Set **CrE = no**, this disables the continuous regulation of the temperature. Default is CrE = no.
 - Set **SSH, superheating setpoint**. A value between 4 and 8 is acceptable. Default is SSH=6.
 - Set **AMS = y**, this starts the **self adaptive regulation**. Default is AMS = y.
 - Set **ATU = y**, this starts the search of the **lowest stable superheat**. Default is ATU = y. This function reduces the setpoint automatically in order to optimize the use of the evaporator, and keeping the superheating regulation stable at the same time. The minimum allowed SH setpoint is LSH+2°C.
 - Set **LSH, low superheating limit**. A value between 2 to 4 is acceptable. Default is LSH = 3.
 - Set **SUB, pressure filter**. Default is SUB = 10. The value can increase up to 20 if the pressure variation response is too fast.
- ### 5. Set the parameters for the temperature regulation.

- Set the temperature **setpoint**. Default is -5°C.
- Set the **differential HY** Default is 2°C.
- If the capacity of the valve is higher than requested, it can be reduced by the parameter. **MnF** (default is 100). A proper setting of **MnF** will reduce the time that the algorithm takes to reach the stability. MnF value does not affect the bandwidth.

7 User Interface

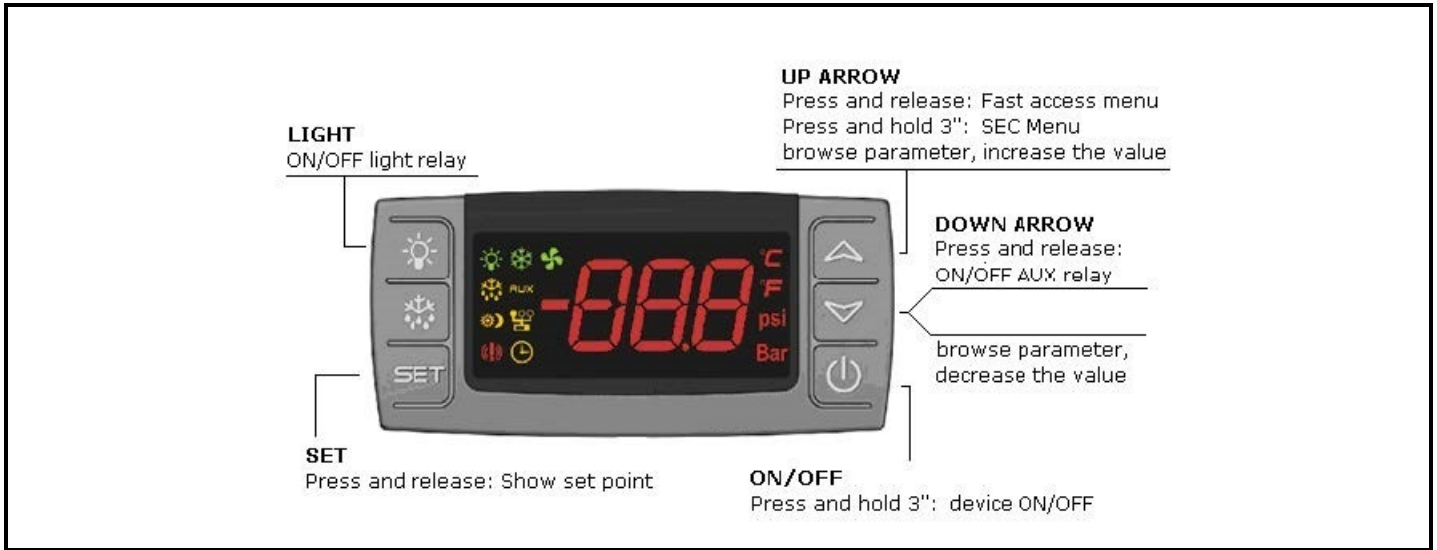

Figure 7-1 - XM679K Display

7.1. Icons

Cooling Output					
Light				Fan	The output is activated when the icon is ON. A delay is present when the icon is blinking.
Defrost		AUX	Auxiliary relay		
Energy Saving			Multimaster enabled		MEASUREMENT UNIT °C, Bar, and ⌚ (time) are ON depending on the selection.
Generic alarm			Clock/time		
DURING PROGRAMMING: The measurement units of temperature and pressure will blink.					

Table 7-1- XM679K Display Icons

7.2. Keyboard Commands

Single commands:

- LIGHT relay: Press the light button
- AUX relay: Press the down arrow button
- Manual defrost: Press the defrost button for three (3) seconds
- ON/OFF: Press the **ON/OFF** button for three (3) seconds (if the function is enabled)
- ES: Press the **ON/OFF** button for three (3) seconds (if the function is enabled)

7.2.1. Double Commands



	Press for three (3) seconds to lock (Pon) or unlock (PoF) the keyboard.
SET + 	Press both keys to exit the programming mode or from a menu; when on submenus EEV , pressing these keys return you to the previous level.
SET + 	Press both keys for three (3) seconds to enter the first level of the programming mode.

Table 7-2 - Keyboard Double Commands

7.3. How to Modify the Air Temperature Regulation Setpoint

The thermostat setpoint is the value used to regulate the air temperature. The regulation output is controlled by the electronic valve or the relay.

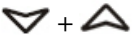

BEGIN	SET	Press the SET key for three (3) seconds (the measurement units will blink).
Value modification	 or 	Use the up arrow and down arrow keys to change the LS and US parameters value.
EXIT	SET	Press the SET key to save the value (the value will blink for two (2) seconds).

Table 7-3 - Modifying the Air Temperature Regulation Setpoint

In any case, it is possible to wait for about 10 seconds to exit. In order to show the air temperature set is sufficient to press and release the SET button, the value is displayed for about 60 seconds for a **KEY COMBINATIONS**.

8 How to Program the Parameters (Pr1 and Pr2)

The device has two programming levels: **Pr1** (direct access) and **Pr2** (password-protected, access for higher level users).







ACCESS to Pr1	SET + 	Press for three (3) seconds to enter the first programming level (Pr1).
Select item	 or 	Press the up arrow or down arrow key to select the parameter or submenu.
Show value	SET	Press the SET button.
Modify	 or 	Press the up arrow or down arrow key to change the value.
Confirm and store	SET	Press SET (the value will blink for three (3) seconds and then display the next parameter).
EXIT	SET + 	Press to exit the programming mode, or wait for 10 seconds to exit.

Table 8-1 - Programming the Parameters (Pr1 and Pr2)

8.1. How to Enter Pr2

To enter **Pr2** programming menu:

1. Press **SET+ down arrow** keys for three (3) seconds to enter **Pr1** menu (the first label will display).
2. Press **down arrow** until the **Pr2** label displays and then press **SET**.
3. A blinking “PAS” label displays. Wait for a few seconds.
4. When a blinking “0 - -” displays, enter the password [**321**] by pressing the up arrow and down arrow keys. Press **SET** to save.

GENERAL STRUCTURE: The first two items, rtC and EEV, are related to the submenus of the other parameters.

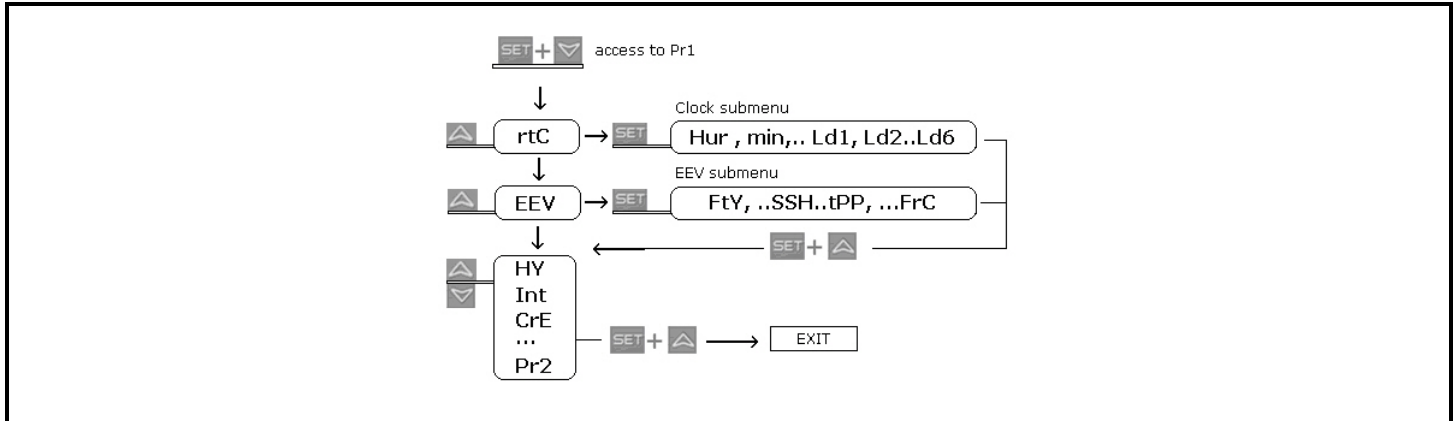

Figure 8-1 - General Structure

- Pressing the **SET + up arrow** keys on the rtC or EEV submenu returns you to the parameter list.
- Pressing the **SET + up arrow** keys on the parameter list exits the screen.

8.2. How to Move a Parameter From Pr1 to Pr2 Level and Vice Versa

Enter the Pr2 level and select the desired parameter then press the **SET+ down arrow** keys. If the LED on the left-hand side of the screen is ON, it means that the parameter is present in Pr1 level; if the LED is OFF, it means that the parameter is not present in Pr1 (Only Pr2).

9 Fast Access Menu

The Fast Access menu contains the list of probes and values that are automatically emptied by the board such as the superheat and percentage of valve opening. The values: nP or noP stands for probe not present or value not emptied, and Err means the value is out of range, or the probe is damaged, not connected or configured incorrectly.





ENTERING THE FAST ACCESS MENU		Press and release the up arrow key. The duration of the menu in case of inactivity is about 3 minutes. Depending on the configuration of the board, the values display.
<p>To select an entry, press the  or , then press SET to view the value or to move to the next value.</p>	<p>MAP Current map (0 to 3): it shows which map is used HM Access to clock menu or reset the RTC alarm An Value of analog output SH Value of superheat. nA = not Available oPP Percentage of valve opening dP1 (Pb1) Value read by probe 1 dP2 (Pb2) Value read by probe 2 dP3 (Pb3) Value read by probe 3 dP4 (Pb4) Value read by probe 4 dP5 (Pb5) Temperature read by probe 5 or value obtained from pressure transducer dP6 (Pb6) Value read by probe 6 dPP Pressure value read by (Pb5) transducer rPP Virtual pressure probe, only on slave rPP Virtual pressure probe, only on slave. rCP Value of P4 remote probe for heaters. It is displayed only with P4C = LAN. If the value is not available “noP” label is displayed. dPr Virtual probe for room temperature regulation [rPA and rPb] rSE Real thermoregulation setpoint: the value includes the sum of SET, HES and/or the dynamic setpoint if the functions are enabled. L°t Minimum room temperature H°t Maximum room temperature tMd Time to next defrost (minutes) LSn Number of devices in the LAN LAn Address list of devices in the LAN GAL To see all the active alarms in each device connected to the LAN</p>	
EXIT	SET + 	Press together or wait the time out for 60 seconds.

Table 9-1 - Fast Access Menu

10 Multi-master Function Menu (SEC)

The function “section” SEC is enabled when the  icon is lit. It allows entering in the remote programming mode from a keyboard not physically connected to the board through the LAN functionality.

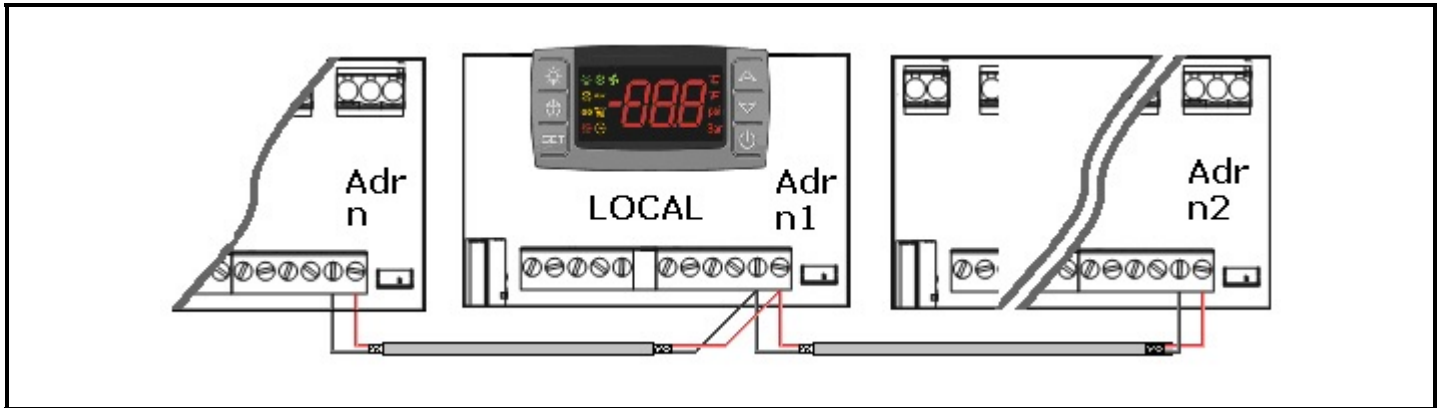

Figure 10-1 - LAN Connection





Action	Button or display	Notes
Enter menu		Press the up arrow key for about three (3) seconds, the  icon will be ON.
Waiting for action	SEC	The menu to change the section will be entered. SEC label will be displayed.
Enter section list	SET	Press SET to confirm. The following list will be available to select the proper network function.
Select proper function	 or  LOC GLb	To gain access only to the local device. To share global command to all the devices connected to the LAN.
Confirm	SET	Select and confirm an entry by pressing SET button.
Exit menu	SET + 	Press SET and up arrow together or wait about 10 seconds.

Table 10-1 - Multi-master Function Menu Action Buttons

(*) The devices on the LAN are indexed by using the Adr parameter (in ascending order).

EXAMPLES:

- To modify the same parameter values in all the devices connected to the LAN: enter the multi-master menu. Select and confirm **ALL**. Exit from the multi-master menu. Enter the programming menu and change the required parameter values. The new values will be changed on all devices connected to the LAN.



CAUTION: At the end of programming, select the LOC section to switch OFF the  icon.

10.1. Synchronized Defrost

The synchronized defrost allows multiple defrosts to be managed from different boards connected through the LAN connection. In this way, the boards can perform simultaneous defrosts with the possibility to end them in a synchronized manner.



CAUTION: In this case, the *Adr* parameter cannot be duplicated because defrost cannot be managed correctly.

BEGIN	SET +	Press for three (3) seconds, the rtC or other will be showed. The measurement unit blinks.
Find Adr		Press the down arrow key several times to find the Adr parameter, then press SET .
Modify Adr	or	Set the value of Adr parameter, then press SET to confirm the parameter.
EXIT	SET +	Press both keys to exit from menu or wait for about 10 seconds.

Table 10-2 - Synchronized Defrost Keys

The **LSn** and **LAN** parameter are used only to show the actual settings (read only). See **Figure 10-2** for an example of configuration:

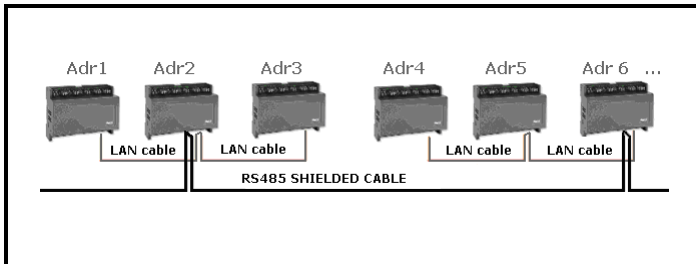

Figure 10-2 - Configuration Example

10.1.1. Daily Defrost From RTC: [EdF = rtC]

- **IdF Parameter:** For safety reasons, force the value of **IdF** at +1 with respect to the interval between the two **Ld** parameters. The **IdF** timer is restarted after defrost and at every power ON.
- **DEFROST START:** At the time selected by the parameters **Ld1** to **Ld6** or **Sd1** to **Sd6**.
- **DEFROST END:** If the probes reach the **dtE** temperature or for maximum **MdF** time.
- **SAFETY and RtC or RtF ALARM:** With clock alarm, the device will use the parameters **IdF**, **dtE** and **MdF**.



CAUTION: Do not set [EdF = rtC] and [CPb = n].

- **MULTIMASTER DEFROST:** All the probes with clock

Par	Unit A (RTC)	Unit B (RTC)	Unit C (RTC)
Adr	n	N + 1	N + 2
IdF	9 hours safety	9 hours safety	9 hours safety
MdF	45 minutes safety	45 minutes safety	45 minutes safety
dtE	12°C safety	12°C safety	12°C safety
Ld1	06:00 1°	06:00 1°	06:00 1°
Ld2	14:00 2°	14:00 2°	14:00 2°
Ld3	22:00 3°	22:00 3°	22:00 3°

Table 10-3 - Multi-master Defrost Example

11 Commissioning

11.1. Clock Setting and RTC Alarm Reset

If the clock is present: [EdF = rtC] enable the defrost from rtc [Ld1 to Ld6].

BEGIN		Press the up arrow key once to access the fast access menu.
Display		HM identify the clock RTC, press SET
Display		HUr = hour -> press SET to save or change MIn = minutes -> press SET to save or change Do not use the other parameters if present.
EXIT	SET +	Press SET + up arrow keys for 10 seconds to reset the RTC alarm.

Table 11-1 - Clock Setting and RTC Alarm Reset

NOTE: The *rtC* clock menu is present also on the second level parameters.



CAUTION! If the board displays the *rtF* alarm, it means that the board has to be replaced.

11.2. Electronic Valve Settings

The following parameters need to be checked:

[1] **Superheat temperature probe:** NtC, PtC, Pt1000 with parameter **P6C**. The sensor has to be fixed at the end of the evaporator.

[2] **Pressure transducer:** [4 to 20mA] or ratio-metric **P5C=420** or **5Vr** with parameter **P5C**.

[3] **Range of measurement:** Check the conversion parameters, **PA4** and **P20**, that are related to the transducer.

TRANSDUCER: For [-0.5/7Bar] or [0.5/8Bar abs], the correct setup is relative pressure with **PA4=-0.5** and **P20=7.0**. For [0.5/12Bar abs], the correct setup is relative pressure with **PA4=-0.5** and **P20=11.00**.

Example of virtual pressure with unique [4 to 20mA] or [0-5V] transducer:

Parameter	XM6x8D_1 w/o transducer	XM6x8D_2 + with transducer	XM6x8D_3 + w/o transducer
Adr	n	n+1	n+2
LPP	LPP = n	LPP =Y	LPP = n
P5C	LAN or probe not connected	P5C = 420 or 0-5V	LAN or probe not connected
PA4	not used	-0.5 bar	not used
P20	not used	7.0 bar	not used

Table 11-2 - Example of virtual pressure with unique 4-20mA or 0-5V transducer

[4] **From the EEV submenu:** Select the correct kind of gas with the **FTy** parameter.

[5] Use the following parameters to set up the correct valve drive (based on the valve data sheet of the manufacturer).

12 Regulation for Superheat: Self Adaptive or Manual Operating Mode

12.1. General Considerations: Self Adaptive or Manual SH Control

The controller can regulate the superheat in manual or self adaptive mode, according to the value of the parameter **AMS**, **auto-tuning enabling**.

- With **AMS = n**: the normal SH regulation is performed.
- With **AMS = y**: the self adaptive SH regulation is performed.

12.2. Manual Operating Mode - AMS = NO

The temperature and SH regulation can be performed in two ways, according to the value of the parameter **CrE**: on/off or continuous. See the Standard temperature regulation in details below.

12.2.1. ON/OFF Temperature Regulation [CrE = n]

1. Temperature regulation is ON/OFF and it depends on the Setpoint and **HY** parameter (differential). Valve is closed when the temperature reaches the setpoint and open when the temperature is higher than setpoint + differential.
2. The superheat is regulated to be closer to its setpoint.
3. With more pauses normally also the humidity is larger.
4. Regulation pauses can be realized using the **Sti** and **Std** parameters (during these pauses the valve is closed).

12.2.2. Continuous Temperature Regulation [CrE = Y] (With Superheat Regulation)

1. The **HY** parameter becomes the temperature band for PI control. A good default value is 5°C.
2. The regulation of injection is continuous and the cooling output is always ON. The ❄️ icon is always ON except for the defrost phase.
3. The superheat is regulated following the **SSH** parameter.
4. Regulation pauses can be realized using **Sti** and **Std** parameters (during these pauses the valve is closed).

- Increasing the **Int** integral time can decrease the speed of reaction of the regulator on the **HY** band.

12.3. Self Adaptive Operating Mode - AMS = YES

Auto-adaptive means to find and maintain the condition of the lowest super heating according to the load and environmental conditions present in a given time on the evaporator.

The parameter **ATU** enables the self adaptive mode in the superheat regulation.

In this functioning the values of **Pb** and **inC** parameter are automatically set by the controller according to the kind of applications and the response of the system.

With the **ATU = YES**, **CrE** must be set to **NO**.

The **self adaptive algorithm** does not affect the functions related to the forced opening of the valve in special situations, such as:

- **Forced opening of the valve at start of regulation**, parameter **SFd** (percentage) and **SFt** (time).
- **Forced opening of the valve after defrost**, parameter **oPd** (percentage) and **Pdd** (time).

12.4. Minimum Stable Superheat Search - AMS = YES, ATU = YES

With the parameter **ATU**, the minimum stable superheat search function is enabled.

With **ATU = yES**, controllers start searching the minimum stable value for the SH. The minimum admitted value in any case is $LSH + 2^{\circ}C$ ($4^{\circ}F$). Take it into consideration, before setting the LSH value.

12.5. Valve Capacity Reducing - MNF Parameter

It is recommend to use the properly sized valve. In case fine tuning is required, the **MnF** parameter allows fine tuning of the valve to its evaporator.

The regulation band is not affected from the modification of the **MnF** parameter.

See the figure below (**Figure 12-1**) for the behavior of the capacity of the valve, when the **MnF** parameter is adjusted.

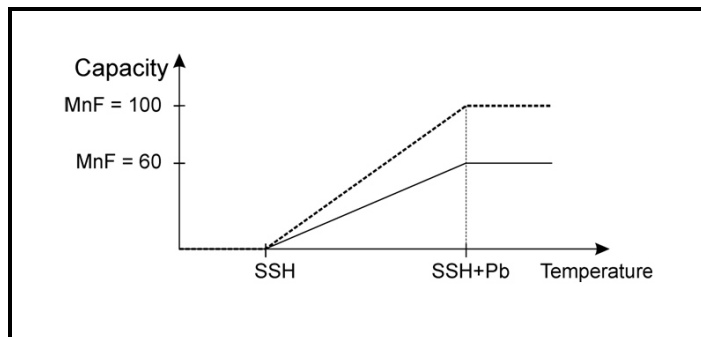

Figure 12-1 - Capacity of Valve in Adjusted MnF Parameter



NOTE: During the soft start phase (**oPE**, **SFd**), **MnF** parameter is not taken in consideration and the capacity of the valve is set by the parameters **oPE** and **oPd**, respectively.

12.6. Pressure Filtering- AnP Parameter

For a good SH regulation, it is important to use a filtered value of the pressure.

This can be done by the parameter **AnP**.

Suggested values:

- From 1-5 evaporators for each racks: **AnP** = 5-6
- From 6-30 evaporators for each racks: **AnP** = 3-4
- More than 30 evaporators for each racks: **AnP** = 2-3

13 Display Messages

	Display	Causes	Notes
KEYBOARD			
1	nod	No display: the keyboard is trying to work with another board that is not working or not present	Press for three (3) seconds the up arrow, enter the SEC menu and select LOC entry.
2	Pon	Keyboard is unlocked	
3	PoF	Keyboard is locked	
4	rSt	Alarm reset	Alarm output deactivated.
5	noP, nP nA	Not present (configuration) Not available (evaluation)	
6	noL	The keyboard is not able to communicate with the XM669K or XM679K	Verify the connection or call Emerson Technical Services.
ALARM FROM PROBE INPUT			
6	P1 P2 P3 P4 P5 P6 PPF CPF	Sensor brake down, value out of range or sensor incorrectly configured P1C, P2C to P6C . PPF can be showed by slaves of pressure that do not receive the value of pressure. CPF is showed when the remote probe 4 is not working.	P1 : the cooling output works with Con and COF With defrost probe on error the defrost is performed only at interval. For P5, P6 and PPF : the percentage of the valve opening is fixed at PEO value.
TEMPERATURE ALARM			
7	HA	Temperature alarm from parameter ALU on probe rAL .	Outputs unchanged.
8	LA	Temperature alarm from parameter ALL on probe rAL .	Outputs unchanged.
9	HAd	Alarm from parameter dLU on probe defrost probe [dPa / dPb].	Outputs unchanged.
10	LAd	Alarm from parameter dLU on probe defrost probe [dPa / dPb].	Outputs unchanged.
11	HAF	Alarm from parameter FLU on probe defrost probe [FPa / FPb].	Outputs unchanged.
12	LAF	Alarm from parameter FLL on probe defrost probe [FPa / FPb].	Outputs unchanged.
DIGITAL INPUT ALARM			
13	dA	Door open alarm from input i1F, i2F or i3F = after delay d1d, d2d or d3d .	Cooling relay and fan follow the odc parameter. Cooling restart as specified on rrd parameter.
14	EA	Generic alarm from digital input i1F, i2F, i3F = EAL .	
15	CA	Severe alarm of regulation lock from digital input i1F, i2F, i3F = bAL .	Regulation output OFF.
16	PAL	Pressure switch lock i1F, i2F or i3F = PAL .	All the outputs are OFF.
ELECTRONIC VALVE ALARM			
17	LOP	Minimum operating pressure threshold from LOP parameter.	The valve output increases its opening of dML quantity every second.

Table 13-1 - Display Messages

	Display	Causes	Notes
18	MOP	Maximum operating pressure threshold from MOP parameter.	The valve output decreases its opening of dML quantity every second.
19	LSH	Low superheating from LSH parameter and SHd delay.	The valve will be closed; the alarm will be showed after SHd delay.
20	HSH	High superheating from HSH parameter and SHd delay.	Only display.
CLOCK ALARM			
21	rtC	Clock settings lost.	Defrost will be performed with IdF till restoring the settings of RTC.
22	rtF	Clock damaged.	Defrost will be performed with IdF.
OTHERS			
23	EE	EEPROM serious problem.	Output OFF.
24	Err	Error with upload/download parameters.	Repeat the operation.
25	End	Parameters have been correctly transferred.	

Table 13-1 - Display Messages

13.1. Alarm Recovery

Probe alarms **P1**, **P2**, **P3**, and **P4** start some seconds after the fault in the related probe; they automatically stop some seconds after the probe restarts normal operation. Check the connections before replacing the probe.

Temperature alarms **HA**, **LA**, **HA2**, and **LA2** automatically stop as soon as the temperature returns to normal values.

Alarms **EA** and **CA** (with **i1F = bAL**) recover as soon as the digital input is disabled. Alarm **CA** (with **i1F = PAL**) recovers only by switching the device OFF and ON.

14 Electronic Expansion Valve Menu (For XM679K Only)

	<ol style="list-style-type: none"> 1. Enter the Programming mode by pressing the SET and DOWN key for few seconds (measurement unit starts blinking). 2. Press arrow until instrument shows EEU label. 3. Press SET, then you will be in the EEV function menu.
---	--

Table 14-1 - Commands

15 Controlling Loads

15.1. Temperature Probe Reference for Regulation

Up to 5 temperature probes can be used for the temperature regulation. It is possible to set the probes used for temperature regulation. Up to 5 Temperature inputs Pb1, Pb2, Pb3, Pb4, Pb6, can be used.

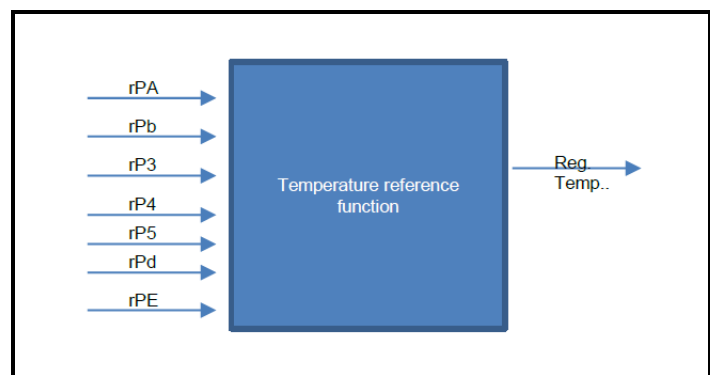

Figure 15-1 - Control With Analog Output

To support above function, the parameters rPA, rPb, rP3, rP4, rP5 are used. Which temperature probe methods of the combined is set by par. rPd among the following: Average, Minimum, Maximum, First, or Mix.

rPd = Avr Average – Average of all valid probes defined as Regulation Probe by par. (rPA, rPb, rP3, rP4, rP5).

rPd = Min Minimum – minimum of all valid probes defined as Regulation Probe by par. (rPA, rPb, rP3, rP4, rP5).

rPd = MAS Maximum – maximum of all valid probes defined as Regulation Probe by par. (rPA, rPb, rP3, rP4, rP5).

rPd = FrS First – first valid probe defined as Regulation Probe by par. (rPA, rPb, rP3, rP4, rP5).

rPd = rPE Mix – this is currently done with “rPE” parameter.

15.1.1. Sensor Failure

In case of multiple temperature sensor regulation: (rPd = Aur, Min, Max or rPE), and with sensor failure, the remaining sensors are used for the regulation.

In case of an all sensors failure, the valve opens at PEO percentage.

15.2. Dual Temp Mode Operation

Controllers can have up to 4 pre-set regulation.

The preset regulation is set in the parameter MAP.

By digital input or supervising system is possible to enable the second regulation mode, set in the parameter M2P.

In this way a dual temp case can be easily set and controlled.

15.2.1. Second Map Function by Digital Input Configuration

By setting on digital input among i1F, i2F, i3F as the “nt” the map set in the parameter M2P is loaded when the digital input is enabled.

15.3. The Solenoid Valve

The regulation is performed according to the temperature measured by the thermostat probe that can be a physical probe or virtual probe obtained by a weighted average between two probes (see parameters table description) with a positive differential from the setpoint. If the temperature increases and reaches setpoint plus differential, the solenoid valve is opened and then it is closed when the temperature reaches the setpoint value again.

In case of a fault in the thermostat probe, the opening and closing time of solenoid valve is configured by “Con” and “CoF” parameters.

15.4. Standard Regulation and Continuous Regulation

The regulation can be performed in two ways: the goal of the first method (**standard regulation**) is reaching the best superheat via a classic temperature regulation obtained using hysteresis. The second method permits the valve to realize a high performance temperature regulation with a good factor of superheat precision. **This second method can be used**

only in centralized plants and is available only with electronic expansion valve by selecting the CrE=Y parameter.

In any case, the regulation is performed via PI regulator that gives the opening percentage to the valve via PWM modulation is explained as follows. Opening percentage is obtained from average of Opening Time respect to CyP time period like following diagram:

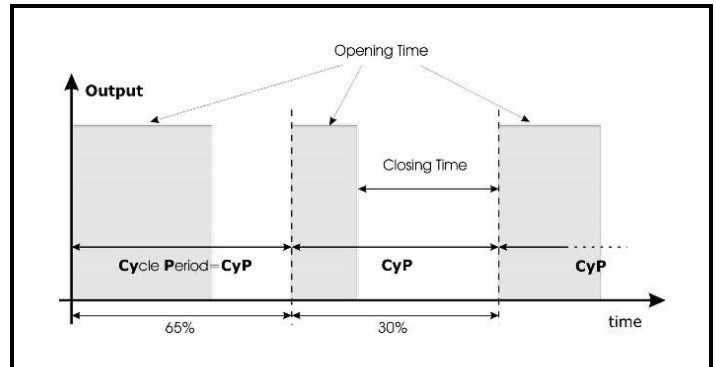

Figure 15-2 - Regulation Diagram

Opening percentage is the percentage of a cycle period where the valve is open. For example, if **CyP=6s** (standard value): “The valve is opened at **50%**”; this means that the valve is opened for **3s** (seconds) during the cycle period.

15.4.1. First Kind of Regulation

In this case, the **Hy** parameter is the differential for standard ON/OFF regulation. In this case the **int** parameter is disregarded. The regulation follows this diagram:

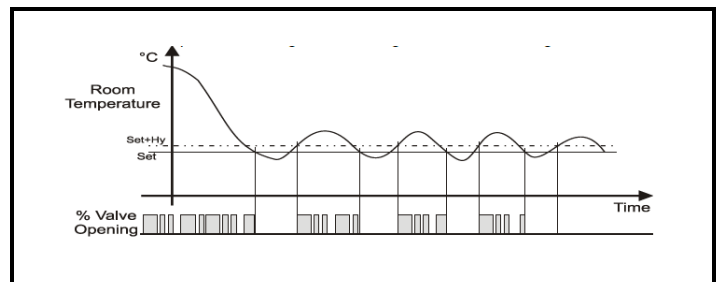

Figure 15-3 - First Kind Regulation Diagram

15.4.2. Second Kind of Regulation – Continuous Regulation (Only XM679K)

In this case, the **Hy** parameter is the proportional band of PI in charge of room temperature regulation and it is recommended to use at least **Hy=5.0°C/10°F**. The **int** parameter is the integral time of the same PI regulator. Increasing **int** parameter the PI regulator becomes slow in reaction and is true vice versa. To disable the integral part of regulation, set **int=0**.

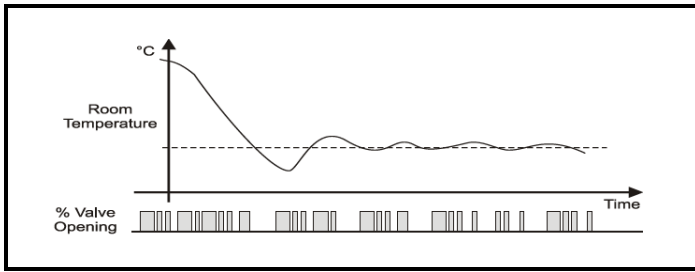

Figure 15-4 - Second Kind Regulation Diagram

15.5. Pump Down Before Defrost

The following parameters have been added:

Pdt pump down type (nu; FAn; F-C)

With **Pdt = nu**, the pump down is not enabled.

With **Pdt = Fan**, when a defrost trigger is given:

- a. Compressor relay will be open.
- b. EEV valve (if present):
 - i. Will be closed with CrE = n, y
 - ii. Will be open with CrE =EUP or EU5
- c. Fan will be forced on for Pdn time

With **Pdt = F-C**, when a defrost trigger is given:

- a. EEV valve (if present):
 - i. Will be closed with CrE = n, y
 - ii. Will be open with CrE =EUP or EU5
- b. Compressor relay and Fan will be forced on for Pdn time

Pdn pump down duration (0 to 255 minutes)

15.6. Defrost

15.6.1. Defrost Starting

In any case, the device checks the temperature that is read by the configured defrost probe before starting the defrost, after that:

- (If RTC is present) Two defrost modes are available through the **tdF** parameter: defrost with electrical heater and hot gas defrost. The defrost interval is controlled by the parameter **EdF**: (**EdF = rtC**) defrost is made in real time depending on the hours set in the parameters **Ld1** to **Ld6** in workdays and in **Sd1** to **Sd6** on holidays; (**EdF = in**) the defrost is made every **ldF** time.
- Defrost cycle starting can be operated locally (manual activation by means of the keyboard or digital input or end of interval time) or the command can come from the master defrost unit of the LAN. In this case, the controller will operate the defrost cycle following the parameters it has programmed. At the end of the drip time, it will wait until all the other controllers of the LAN finish their defrost cycle before restarting the normal

regulation of the temperature according to **dEM** parameter.

- Each time any of the LAN controller begins a defrost cycle, it issues the command into the network making all the other controllers start their own cycle. This allows a perfect synchronization of the defrost in the whole multiplexed cabinet according to the **LMd** parameter.
- **Differential defrost**: Selecting the **dPA** and **dPb** probes and by changing the **dtP** and **ddP** parameters, the defrost can be started when the difference between **dPA** and **dPb** probes is lower than **dtP** for all **ddP** time. This is useful to start defrost when a low thermal exchange is detected. If [**ddP = 0**], this function is disabled.

15.6.2. Minimum Defrost Time

The “**ndt**” (0 to MnF) Minimum Defrost Time, set the minimum defrost duration, when the defrost is ended by evaporator temperature probe.

The **ndt** time is taken in account every time the defrost is triggered, independently from the value of end defrost temperature probe and end defrost digital input status.

15.6.3. Defrost Ending

- When defrost is started via **rtC**, the maximum defrost duration is obtained from the **Md** parameter and the defrost end temperature is obtained from the **dtE** parameter (and **dtS** if two defrost probes are selected).
- If **dPA** and **dPb** are present and [**d2P = Y**], the device stops the defrost procedure when **dPA** is higher than **dtE** temperature and **dPb** is higher than **dtS** temperature.

At the end of defrost, the drip time is controlled through the **Fdt** parameter.

15.6.4. Kind of Defrost

The kind of defrost is set by parameter **tdF** among the following possibilities.

- tdF = Air: natural defrost.** Defrost is made by opening the compressor/solenoid relay. The fan during defrost depends on the parameter **Fnc**. Defrost relay is off. The valve is closed.
- tdF = EL: defrost with electrical heater.** Defrost is made by opening the compressor/solenoid relay. The fan during defrost depends on the parameter **Fnc**. Defrost relay is on. The valve is closed.
- tdF = in: hot gas defrost.** Defrost is made by closing the compressor/solenoid relay. The fan during defrost depends on the parameter **Fnc**. Defrost relay is on. The valve opening percentage during the defrost is set by the par. **oPd**.

15.7. On Demand Defrost

15.7.1. Description

Controller can perform on demand defrost. It is based on the behavior of evaporator temperature.

Controller monitors the evaporator temperature and triggers a defrost if some conditions are satisfied. For defrost efficiency it is important to place the “end defrost probe”, usually P2, in the coldest place of the evaporator, usually immediately after the expansion valve.

NOTE: Because of different types of evaporators and consequentially behaviors, it is recommended to test and validate this algorithm in a climatic chamber before applying it in the field.

15.7.2. Parameters and Settings

The «On Demand Defrost» can be activated with the following settings:

CrE="n", EdF="Aut"

cdt: Evaporator temperature differential to trigger a defrost (default cdt = 4°K)

nbd: Minimum compressor run before automatic defrost (or minimum time of activation of solenoid valve) it has to be set properly. It prevents defrost from starting (default nbd = 4.0 hours)

Mbd: Max compressor run before automatic defrost (or max time of activation of solenoid valve): it has to be set properly. If reached a defrost is triggered (default Mbd = 16.0 hours)

nct: Minimum evap. temperature, it has to be set properly. a defrost is triggered when this temperature reached (default nct = -30°C)

NOTE: With CrE="y" or CrE="EUP" or CrE=EU5 only «RTC defrost» and «interval defrost» are allowed. With EdF="Aut" & CrE="y" or CrE="EUP" or CrE=EU5 the «interval defrost» will be performed, as with EdF = in

15.7.3. Exceptions

1. A defrost cannot be triggered if the compressor has not run more than the minimum time (*nbd parameter*) since the last defrost or initial power up. (Resolution hh.m)
2. If the compressor has run for more than maximum time since the last defrost or initial power up (*Mbd parameter*), a defrost is triggered regardless of coil temperature.
3. If the coil temperature reaches a very low temperature, (*nct parameter*), a defrost is triggered regardless of *cdt* value.

15.8. Fans

15.8.1. Control with Relay

The fan control mode is selected by means of the **FnC** parameter:

- **C-n** = Running with the solenoid valve, OFF during defrost

- **C-Y** = Running with the solenoid valve, ON during defrost
- **O-n** = Continuous mode, OFF during defrost
- **O-Y** = Continuous mode, ON during defrost

An additional parameter **FSt** provides the setting of the temperature, detected by the evaporator probe, above which the fans are always OFF. This can be used to verify that air is circulated only if this temperature is lower than set in the **FSt**.

15.8.2. Control With Analog Output (If Present)

The modulating output [**trA** = **rEG**] works in a proportional manner (excluding the first **AMt** seconds where the fans speed is the maximum; 10 seconds is the minimum value). The regulation setpoint is relative to the regulation setpoint and is indicated by **ASr**, the proportional band is always located above the [**SET** + **ASr**] value and its value is **PbA**. The fans are at minimum speed **AMi** when the temperature read by the fan probe is [**SET** + **ASr**] and the fan is at maximum speed (**AMA**) when the temperature is [**SET** + **ASr** + **PbA**].

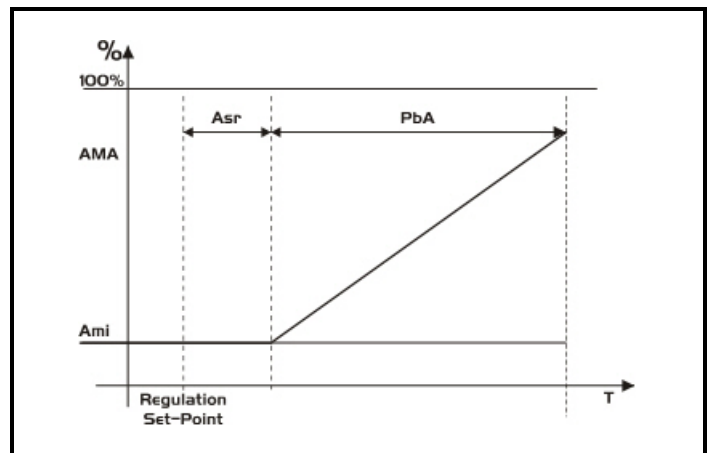

Figure 15-5 - Control With Analog Output

15.9. Anti-Sweat Heaters

Anti-sweat heater regulation can be performed with the on board relay (if **OA6** = **AC**) or with the analog output (if present by setting **trA** = **AC**). However, the regulation can be performed in two ways:

- Without real dewpoint information: in this case the default value for dewpoint is used (**SdP** parameter).
- Receiving dewpoint from **XWEB5000** system: the **SdP** parameter is overwritten when a valid value for dewpoint is received from XWEB. In case the XWEB link is lost, **SdP** is the value that will be used for safety.

Best performance can be obtained using probe 4. In this case, the regulation follows the chart illustrated in **Figure 15-6**:

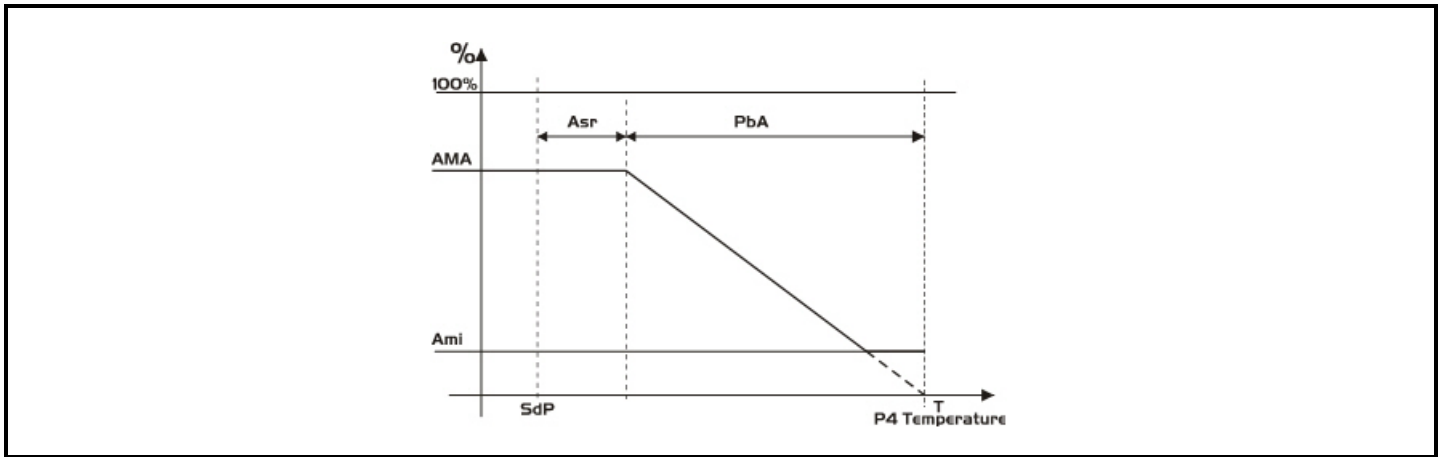

Figure 15-6 - Anti-Sweat Heaters

Probe 4 should be placed on the showcase glass. For each cabinet, only one probe 4 (P4) can be used; the P4 will send its value to the other sections that are connected to the LAN.

Functioning with Probe 4 within the LAN:

Parameter	XM6x9K_1 Without Probe 4	XM6x9K_2 + With Probe 4	XM6x9K_3+ Without Probe 4
Adr	n	n + 1	n + 2
LCP	LCP = n	LCP = Y	LCP = n
P4C	LAN or probe not connected	P4C = NTC, PtC or PtM	LAN or probe not connected
trA	trA = AC if the device has the analog output		
OA6	OA6 = AC if the device will use the AUX relay for regulation		

Table 15-1 - Functioning with Probe 4 within the LAN

Functioning Without Probe 4:

Parameter	XM6x8D Without Probe 4
P4C	nP
AMt	% of ON

Table 15-2 - Functioning Without Probe 4

In this case, regulation is performed by switching the auxiliary relay ON and OFF on a 60-minutes time base. The ON time will be the **AMt** value, so that the relay will be ON for **AMt** minutes and OFF for **[60-AMt]** minutes.

In case of P4 error or if P4 is absent, the output is at **AMA** value for the **AMt** time, then the output is at **0** value for the time **[255 - AMt]** performing a simple PWM modulation.

15.10. Cleaning Mode Function by Digital Input Configuration

The “**cLn**” value is added to the functions of the digital input.

The function has the same basic features of the stand by function, but with the following differences:

- By the parameter **LcL** (No, Yes) it is possible to set the light ON or OFF during cleaning mode. This parameter **LcL** can be overridden by the light button or by Light on/off MODBUS command.
- By the parameter **FcL** (No, Yes) it is possible to set fan ON or OFF during cleaning mode. In case the fan is ON, the **FSt** parameter (fan stop temperature) is overridden.

15.10.1. Display

During the Cleaning Status, the display shows the “cLn” message.

15.11. Auxiliary Output

The auxiliary output is switched ON and OFF by means of the corresponding digital input, or by pressing and releasing the down arrow key.

16 Parameter List

Parameter	Description
REGULATION	
Set	Temperature setpoint (LS to US)
rtC	Access to CLOCK submenu (if present)
EEU	Access to EEV submenu (only XM679K)
Hy	Differential: (0, 1 to 25,5°C; 1 to 45°F): Intervention differential for setpoint, always positive. Solenoid valve Cut IN is Setpoint Plus Differential (Hy). Solenoid valve Cut OUT is when the temperature reaches the setpoint.
Int	Integral time for room temperature regulation (Only XM679K): (0 to 255 seconds) Integral time for room temperature PI regulator. 0 = no integral action.
CrE	Continuous regulation activation (Only XM679K): (N to Y) n= standard regulation; Y= continuous regulation. Use it only in centralized plants.
LS	Minimum setpoint limit: (-55.0°C to SET; -67°F to SET) Sets the minimum acceptable value for the setpoint.
US	Maximum setpoint limit: (SET to 150°C; SET to 302°F) Set the maximum acceptable value for setpoint.
OdS	Outputs activation delay at start up: (0 to 255 minutes) This function is enabled at the initial start up of the instrument and inhibits any output activation for the period of time set in the parameter. (AUX and Light can work)
AC	Anti-short cycle delay: (0 to 60 minutes) Interval between the solenoid valve stop and the following restart.
CCt	Compressor ON time during continuous cycle: (0.0 to 24.0 hours; resolution 10 minutes) Allows to set the length of the continuous cycle: compressor stays on without interruption for the CCt time. Can be used, for instance, when the room is filled with new products.
CCS	Setpoint for continuous cycle: (-55 to 150°C / -67 to 302°F) It sets the setpoint used during the continuous cycle.
Con	Solenoid valve ON time with faulty probe: (0 to 255 minutes) Time during which the solenoid valve is active in case of faulty thermostat probe. With CON = 0 solenoid valve is always OFF.
CoF	Solenoid valve OFF time with faulty probe: (0 to 255 minutes) Time during which the solenoid valve is OFF in case of faulty thermostat probe. With COF = 0 solenoid valve is always active.
DISPLAY	
CF	Temperature measurement unit: °C = Celsius; °F = Fahrenheit. WARNING: When the measurement unit is changed, the parameters with temperature values have to be checked.
PrU	Pressure mode: (rEL or AbS) It defines the mode to use the pressure. WARNING: The setting of PrU is used for all the pressure parameters. If PrU=rEL all pressure parameters are in relative pressure unit, if PrU=AbS all pressure parameters are in absolute pressure unit. (Only XM679K)
PMU	Pressure measurement unit: (bAr – PSI - MPA) It selects the pressure measurement units. MPA= the value of pressure measured by kPA * 10. (Only XM679K)

Table 16-1 - Parameter List

Parameter	Description
PMd	Way of displaying pressure: (tEM - PrE) It permits showing the value measured by pressure probe with tEM = temperature or by PrE= pressure; (Only XM679K)
rES	Resolution (for °C): (in = 1°C; dE = 0.1 °C) Allows decimal point display.
rEP	Resolution for % value: (in = integer; dE = with decimal point) Allows decimal point display for percentage values.
Lod	Instrument display: (nP; P1; P2, P3, P4, P5, P6, tEr, dEF) It selects which probe is displayed by the instrument. P1, P2, P3, P4, P5, P6, tEr = virtual probe for thermostat, dEF = virtual probe for defrost.
rEd	Remote display: (nP; P1; P2, P3, P4, P5, P6, tEr, dEF) It selects which probe is displayed by the X-REP. P1, P2, P3, P4, P5, P6, tEr = virtual probe for thermostat, dEF = virtual probe for defrost.
dLy	Display delay: (0 to 24.0 minutes; resolution 10 seconds) When the temperature increases, the display is updated of 1 °C/1°F after this time.
rPA	Regulation probe A: (nP; P1; P2, P3, P4, P6) First probe used to regulate room temperature. If rPA=nP the regulation is performed with real value of rPb.
rPb	Regulation probe B: (nP; P1; P2, P3, P4, P5) Second probe used to regulate room temperature. If rPb=nP the regulation is performed with real value of rPA.
rP3	Regulation probe 3: (nP; P1; P2, P3, P4, P6) Third probe used to regulate room temperature, with rPd = Aur or Min or MA or FrS.
rP4	Regulation probe 4: (nP; P1; P2, P3, P4, P6) Fourth probe used to regulate room temperature, with rPd = Aur or Min or MA or FrS.
rP5	Regulation probe 5: (nP; P1; P2, P3, P4, P6) Fifth probe used to regulate room temperature, with rPd = Aur or Min or MA or FrS.
rPd	Temperature Regulation Strategy: (Aur, Min, MAS, FrS, rPE) Aur: Average of all valid probes defined as Regulation Probe Min: Minimum value of all valid probes defined as Regulation Probe MaS: Maximum of all valid probes defined as Regulation Probe FrS: First valid probe defined as Regulation Probe rPE: Mix between rPA and rPb defined by rPE parameter

Table 16-1 - Parameter List

Parameter	Description																																																																					
rPE	Regulation virtual probe percentage: (0 to 100%) It defines the percentage of the rPA respect to rPb. The value used to regulate room temperature is obtained by: Value_for_room = (rPA * rPE + rPb * (100-rPE))/100																																																																					
ELECTRONIC EXPANSION VALVE SUBMENU (Only XM679K)																																																																						
FtY	Kind of gas:																																																																					
	<table border="1"> <thead> <tr> <th>LABEL</th> <th>REFRIGERANT</th> <th>OPERATING RANGE</th> </tr> </thead> <tbody> <tr><td>R22</td><td>r22</td><td>-58 to 120°F / -50 to 60°C</td></tr> <tr><td>134</td><td>r134A</td><td>-58 to 120°F / -50 to 60°C</td></tr> <tr><td>290</td><td>r290 – Propane</td><td>-58 to 120°F / -50 to 60°C</td></tr> <tr><td>404</td><td>r404A</td><td>-94 to 120°F / -70 to 60°C</td></tr> <tr><td>47A</td><td>r407A</td><td>-58 to 120°F / -50 to 60°C</td></tr> <tr><td>47C</td><td>r407C</td><td>-58 to 120°F / -50 to 60°C</td></tr> <tr><td>47F</td><td>r407F</td><td>-58 to 120°F / -50 to 60°C</td></tr> <tr><td>410</td><td>r410A</td><td>-58 to 120°F / -50 to 60°C</td></tr> <tr><td>448</td><td>r448A</td><td>-49 to 120°F / -45 to 60°C</td></tr> <tr><td>449</td><td>r449A</td><td>-49 to 120°F / -45 to 60°C</td></tr> <tr><td>450</td><td>r450A</td><td>-49 to 120°F / -45 to 60°C</td></tr> <tr><td>452</td><td>r452A</td><td>-94 to 120°F / -70 to 60°C</td></tr> <tr><td>507</td><td>r507</td><td>-94 to 120°F / -70 to 60°C</td></tr> <tr><td>513</td><td>r513A</td><td>-49 to 120°F / -45 to 60°C</td></tr> <tr><td>CO2</td><td>r744 - Co2</td><td>-58 to 77°F / -50 to 25°C</td></tr> <tr><td>15b</td><td>r515b</td><td>-22 to 120°F / -30 to 60°C</td></tr> <tr><td>54A</td><td>r454A</td><td>-58 to 120°F / -50 to 60°C</td></tr> <tr><td>54b</td><td>r454B</td><td>-58 to 120°F / -50 to 60°C</td></tr> <tr><td>54C</td><td>r454C</td><td>-58 to 120°F / -50 to 60°C</td></tr> <tr><td>55A</td><td>r455A</td><td>-40 to 120°F / -40 to 60°C</td></tr> <tr><td>4yF</td><td>r1234yf</td><td>-58 to 120°F / -50 to 60°C</td></tr> <tr><td>4EE</td><td>r1234ze</td><td>-58 to 120°F / -50 to 60°C</td></tr> </tbody> </table>	LABEL	REFRIGERANT	OPERATING RANGE	R22	r22	-58 to 120°F / -50 to 60°C	134	r134A	-58 to 120°F / -50 to 60°C	290	r290 – Propane	-58 to 120°F / -50 to 60°C	404	r404A	-94 to 120°F / -70 to 60°C	47A	r407A	-58 to 120°F / -50 to 60°C	47C	r407C	-58 to 120°F / -50 to 60°C	47F	r407F	-58 to 120°F / -50 to 60°C	410	r410A	-58 to 120°F / -50 to 60°C	448	r448A	-49 to 120°F / -45 to 60°C	449	r449A	-49 to 120°F / -45 to 60°C	450	r450A	-49 to 120°F / -45 to 60°C	452	r452A	-94 to 120°F / -70 to 60°C	507	r507	-94 to 120°F / -70 to 60°C	513	r513A	-49 to 120°F / -45 to 60°C	CO2	r744 - Co2	-58 to 77°F / -50 to 25°C	15b	r515b	-22 to 120°F / -30 to 60°C	54A	r454A	-58 to 120°F / -50 to 60°C	54b	r454B	-58 to 120°F / -50 to 60°C	54C	r454C	-58 to 120°F / -50 to 60°C	55A	r455A	-40 to 120°F / -40 to 60°C	4yF	r1234yf	-58 to 120°F / -50 to 60°C	4EE	r1234ze	-58 to 120°F / -50 to 60°C
	LABEL	REFRIGERANT	OPERATING RANGE																																																																			
	R22	r22	-58 to 120°F / -50 to 60°C																																																																			
	134	r134A	-58 to 120°F / -50 to 60°C																																																																			
	290	r290 – Propane	-58 to 120°F / -50 to 60°C																																																																			
	404	r404A	-94 to 120°F / -70 to 60°C																																																																			
	47A	r407A	-58 to 120°F / -50 to 60°C																																																																			
	47C	r407C	-58 to 120°F / -50 to 60°C																																																																			
	47F	r407F	-58 to 120°F / -50 to 60°C																																																																			
	410	r410A	-58 to 120°F / -50 to 60°C																																																																			
	448	r448A	-49 to 120°F / -45 to 60°C																																																																			
	449	r449A	-49 to 120°F / -45 to 60°C																																																																			
	450	r450A	-49 to 120°F / -45 to 60°C																																																																			
	452	r452A	-94 to 120°F / -70 to 60°C																																																																			
	507	r507	-94 to 120°F / -70 to 60°C																																																																			
	513	r513A	-49 to 120°F / -45 to 60°C																																																																			
	CO2	r744 - Co2	-58 to 77°F / -50 to 25°C																																																																			
	15b	r515b	-22 to 120°F / -30 to 60°C																																																																			
	54A	r454A	-58 to 120°F / -50 to 60°C																																																																			
54b	r454B	-58 to 120°F / -50 to 60°C																																																																				
54C	r454C	-58 to 120°F / -50 to 60°C																																																																				
55A	r455A	-40 to 120°F / -40 to 60°C																																																																				
4yF	r1234yf	-58 to 120°F / -50 to 60°C																																																																				
4EE	r1234ze	-58 to 120°F / -50 to 60°C																																																																				
ATU	Self adaptive SH regulation enabling (No; Yes) This parameter enables the self adaptive regulation of the superheat. CrE = no must to be set, when this function is enabled.																																																																					
AMS	Minimum STABLE superheat search (No; Yes) This parameter enables the search of the minimum stable superheat. The lowest admitted value is LSH+2°C.																																																																					
SSH	Superheat setpoint: [0.1°C to 25.5°C] [1°F to 45°F] It is the value used to regulate superheat																																																																					
SHy	Differential for low superheat function: This value is used by X-WEB with XeCO2 function. When the monitoring system enable the low superheat Shy is subtracted to the SSH setpoint (-12.0 to 12.0°C).																																																																					
Pb	Proportional band: (0.1 to 60.0 / 1 to 108°F) PI proportional band.																																																																					
PbH	Dead band for superheat regulation: It is a band across the SH setpoint, inside this band the valve opening percentage is not updated.																																																																					
rS	Band Offset: (-12.0 to 12.0°C / -21 to 21°F) PI band offset																																																																					
inC	Integration time: (0 to 255 seconds) PI integration time																																																																					
dFC	Derivative time: (0 to 255 seconds) PID derivative time																																																																					
PEd	Delay before stopping regulation with probe error: 0 to 239 seconds - On(240)																																																																					

Table 16-1 - Parameter List

Parameter	Description
PEO	Probe Error opening percentage: (0 to 100%) If a probe error occurs, valve opening percentage is PEO.
SFd	Start Function duration: (0.0 to 42.0 minutes: resolution 10 seconds) It sets start function duration and post-defrost duration. During this phase the SH alarms are overridden.
SFP	Start opening Percentage: (0 to 100%) Opening valve percentage when start function is active. This phase duration is SFd time.
OHg	Opening Percentage during hot gas defrost: (0 to 100%) Opening valve percentage when hot gas defrost is active.
Pdd	Post Defrost Function duration: (0.0 to 42.0 minutes: resolution 10 seconds) It sets start function duration and post-defrost duration. During this phase the alarms are overridden.
OPd	Opening Percentage after defrost phase: (0 to 100%) Opening valve percentage when after defrost function is active. This phase duration is Pdd time.
LnF	Minimum opening percentage at normal Functioning: (0 to 100%) During regulation it sets the minimum valve opening percentage; (0 to MnF%)
MnF	Maximum opening percentage at normal Functioning: (LnF to 100) During regulation it sets the maximum valve opening percentage.
dCL	Regulation off delay, when the setpoint is reached (0 to 255 seconds)
Fot	Forced opening percentage: (0 to 100% - nu) It permits to force the valve opening to the specified value. This value overwrite the value calculated by PID algorithm. WARNING: To obtain the correct superheat regulation you have to set Fot=nu.
LPL	Lower Pressure Limit for superheat regulation: (PA4 to P20 bar / psi / kPA*10) When suction pressure comes down to LPL the regulation is performed with a LPL fixed value for pressure, when pressure comes back to LPL the normal pressure value is used. (related to PrM parameter)
MOP	Maximum Operating Pressure threshold: (PA4 to P20 bar / psi / kPA*10) If suction pressure exceeds maximum operating pressure value, instrument signals situation with MOP alarm. (related to PrM parameter)
dMP	Delay for Maximum Operating Pressure threshold alarm signaling: (0 to 255 seconds) when a MOP alarm occurs it is signaled after dMP time.
LOP	Minimum Operating Pressure threshold: (PA4 to P20 bar / psi / kPA*10) If the suction pressure comes down to this value a low pressure alarm is signaled with LOP alarm. (related to PrM parameter).
dLP	Delay for Minimum Operating Pressure threshold alarm signaling: (0 to 255 seconds) When a LOP alarm occurs it is signaled after dMP time.
dML	Opening steps variation during MOP and LOP: (0 to 100%) When a MOP alarm occurs valve will close of the dML percentage every cycle period until MOP alarm is active. When LOP occurs valve will open of the dML percentage every cycle period until LOP alarm is active.
AAS	Low superheat alarm with "XeCO2 function active: N = No superheat alarm, Y= Low superheat alarm is still signaled.
HSH	High Superheat alarm: (LSH to 80.0°C / LSH to 144°F) When superheat exceeds this value an high superheat alarm is signaled after interval SHd.
LSH	Low Superheat alarm: (0.0 to HSH °C / 0 to HSH °F) When superheat goes down to this value a low superheat alarm is signaled after interval SHd.
dHS	High superheat alarm activation delay: (0.0 to 42.0 minutes: resolution 10 seconds) When a high superheat alarm occurs, the time dHS has to pass before alarm signaling.

Table 16-1 - Parameter List

Parameter	Description
dLS	Low superheat alarm activation delay: (0.0 to 42.0 minutes: resolution 10 seconds) When a low superheat alarm occurs, the time SHd has to pass before alarm signaling.
LSA	Opening percentage decrease with low Superheat alarm: (0 to 100%)
FrC	Fast-recovery Constant: (0 to 100 seconds) Permits to increase integral time when SH is below the setpoint. If FrC = 0 fast recovery function is disabled.
AnP	Pressure filter (0 to 100) It uses the last average values of the pressure to calculate the superheat. E.I. with AnP = 5 controller uses the average pressure in the last 5 seconds to calculate the SH. NOTE: Avoid values higher than 10
Ant	Temperature filter (0 to 100) It uses the last average values of the temperature to calculate the superheat. E.I. with Ant = 5 controller uses the average temperature in the last 5 seconds to calculate the SH. NOTE: Avoid values higher than 10
SLb	Reaction time (0 to 255 seconds): Time to update the valve open percentage. E.I. With SLb = 24: the valve open percentage is updated every 24 seconds.
CyP	Cycle Period: (1 to 15 seconds) It permits to set cycle time.
DEFROST	
dPA	Defrost Probe A: (nP; P1; P2, P3, P4, P6) First probe used for defrost. If rPA = nP the regulation is performed with real value of dPb.
dPb	Defrost Probe B: (nP; P1; P2, P3, P4, P6) Second probe used for defrost. If rPB=nP the regulation is performed with real value of dPA. Value_for_defrost= (dPA * dPE + dPb * (100-dPE))/100
tdF	Defrost type: (Air, EL, in) Air = Air defrost (relay is not switched on during defrost) EL = Defrost with electrical heater in = Hot gas defrost
EdF	Defrost mode: (rtc – in- Aut) (only if RTC is present) rtc = defrost activation via RTC; in = defrost activation with idf ; Aut = on demand defrost.
Srt	Heater setpoint during defrost: (-55.0 to 150.0°C; -67 to 302°F) If tdF = EL during the defrost the defrost relay perform an ON/OFF regulation with Srt as setpoint.
Hyr	Differential for heater: (0.1°C to 25.5°C, 1°F to 45°F) the differential for heater.
tod	Time out for heater: 0 to 255 (minutes) if the defrost probe temperature is bigger than Srt for all tod time the defrost ends although the defrost probe temperature is lower than dtE or dtS. It permits to reduce defrost duration.
d2P	Defrost with two probes: (N – Y) N = only the dPA probe is used to defrost management; Y = defrost is managed with dPA probe and dPb probe. Defrost can performed only if both probe value are lower than dtE for dPA probe and dtS for dPb probe.
dtE	Defrost termination temperature (Probe A): (-55,0 to 50,0°C; -67 to 122°F) (Enabled only when the evaporator probe is present) sets the temperature measured by the evaporator probe dPA which causes the end of defrost.
dtS	Defrost termination temperature (Probe B): (-55,0 to 50,0°C; -67 to 122°F) (Enabled only when the evaporator probe is present) sets the temperature measured by the evaporator probe dPb which causes the end of defrost.
IdF	Interval between defrosts: (0 to 120 hours) Determines the time interval between the beginning of two defrost cycles.

Table 16-1 - Parameter List

Parameter	Description
idE	<p>Time to next defrost log into not volatile memory No: Time to next defrost is not logged into non volatile memory, this means controller will use the idF interval after a power off. E.I. idF = 8: controller performs a defrost every 8 hours. If controller is switched off, independently from when last defrost happened, at power on it will do the first defrost after 8 hours. Yes: Time to next defrost is logged into non volatile memory, this means controller will use it after a power off. E.I. idF = 8: controller performs a defrost every 8 hours. If controller is switched off 6 hours after last defrost, at power on it will do the first defrost after 2 hours (6+2 = 8). It is useful in places subjected to frequent power outages.</p>
ndt	Minimum duration of defrost: (0 to MdF minutes) It sets the minimum defrost duration, independently from the temperature reached by the end defrost probes.
MdF	Maximum duration of defrost: (ndt to 255 minutes) When dPA and dPb are not present, it sets the defrost duration, otherwise it sets the maximum duration for defrost.
dSd	Start defrost delay: (0 to 255 minutes) This is useful when different defrost start times are necessary to avoid overloading the plant.
dFd	Display during defrost: rt = real temperature; it = temperature reading at the defrost start; Set = setpoint; dEF = "dEF" label.
dAd	Defrost display time out: (0 to 255 minutes) Sets the maximum time between the end of defrost and the restarting of the real room temperature display.
Fdt	Drain down time: (0 to 255 minutes) Time interval between reaching defrost termination temperature and the restoring of the control's normal operation. This time allows the evaporator to eliminate water drops that might have formed due to defrost.
dPo	First defrost after start-up: Y = Immediately; N = after the IdF time
dAF	Defrost delay after continuous cycle: (0 to 23.5 hours) Time interval between the end of the fast freezing cycle and the following defrost related to it.
PUMP DOWN	
Pdt	<p>Pump down type (nu, FAn, F-C) nu: Pump down disabled FAn: Pump down enabled. Fan is activated for pump down duration, compressor relay/solenoid valve is switched off with CrE = N/Y o or activated with CrE = EUP or EU5. F-C: Pump down enabled. Fan and compressor relay are activated for pump down duration. See above for solenoid valve behavior.</p>
Pdn	Pump down duration (0 to 255 minutes)
ON DEMAND DEFROST	
Ctd	Differential for defrost start (0.1°C to 25.5°C, 1°F to 45°F)
nbd	Minimum Compressor run time before defrost 0.0 to 24h00 minutes)
Mdb	Maximum Compressor run time before defrost (0.0 to 24h00 minutes)
nct	Minimum coil temperature to trigger a defrost (-55.0°C to 150.0°C; 67°F to 302°F]
FAN	
FAP	Fan probe A: (nP; P1; P2, P3, P4, P5) First probe used for fan. If FPA = nP the regulation is performed with real value of FPB.
FnC	Fan operating mode: C-n = running with the solenoid valve, OFF during the defrost; C-y = running with the solenoid valve, ON during the defrost; O-n = continuous mode, OFF during the defrost; O-y = continuous mode, ON during the defrost.
Fnd	Fan delay after defrost: (0 to 255 minutes) The time interval between the defrost end and evaporator fans start.

Table 16-1 - Parameter List

Parameter	Description
Fct	Temperature differential avoiding short cycles of fans (0.0°C to 50.0°C; 0°F to 90°F) If the difference of temperature between the evaporator and the room probes is more than the value of the Fct parameter, the fans are switched on.
FSt	Fan stop temperature: (-50 to 110°C; -58 to 230°F) Setting of temperature, detected by evaporator probe, above which the fan is always OFF.
FHy	Differential to restart fan: (0.1°C to 25.5°C) (1°F to 45°F) When stopped, fan restarts when fan probe reaches FSt-FHy temperature.
tFE	Fan regulation by temperature during defrost (N,Y)
Fod	Fan activation time after defrost: (0 to 255 minutes) It forces fan activation for indicated time.
Fon	Fan ON time: (0 to 15 minutes) with Fnc = C_n or C_y, (fan activated in parallel with compressor). it sets the evaporator fan ON cycling time when the compressor is off. With Fon = 0 and FoF ≠ 0 the fan are always off, with Fon = 0 and FoF = 0 the fan are always off.
FoF	Fan OFF time: (0 to 15 minutes) with Fnc = C_n or C_y, (fan activated in parallel with compressor). it sets the evaporator fan off cycling time when the compressor is off. With Fon = 0 and FoF ≠ 0 the fan are always off, with Fon = 0 and FoF = 0 the fan are always off.
MODULATING OUTPUT - if present	
trA	Kind of regulation with PWM output: (UAL – rEG – AC) It selects the functioning for the PWM output. UAL = the output is at FSA value; rEG = the output is regulated with fan algorithm described in fan section; AC = anti-sweat heaters control (require the XWEB5000 system).
SOA	Fixed value for analog output: (0 to 100%) Value for the output if trA=UAL .
SdP	Default value for Dewpoint: (-55,0 to 50,0°C; -67 to 122°F) Default value of dewpoint used when there is no supervising system (XWEB5000). Used only when trA = AC .
ASr	Dew-point offset (trA=AC) / Differential for modulating fan regulation (trA = rEG): (-25.5°C to 25.5°C) (-45°F to 45°F).
PbA	Differential for anti-sweat heaters: (0.1°C to 25.5°C) (1°F to 45°F)
AMi	Minimum value for analog output: (0 to AMA)
AMA	Maximum value for analog output: (Ami to 100)
AMt	Anti-sweat heaters cycle period (trA=AC)/ Time with fan at maximum speed (trA=rEG): (0 to 255 seconds) when the fan starts, during this time the fan is at maximum speed.
ALARMS	
rAL	Probe for temperature alarm: (nP - P1 - P2 - P3 - P4 - P5 – tEr) It selects the probe used to signal alarm temperature.
ALC	Temperature alarm configuration: rE = High and Low alarms related to Setpoint; Ab = High and low alarms related to the absolute temperature.
ALU	High temperature alarm setting: (ALC= rE, 0 to 50°C or 90°F / ALC= Ab, ALL to 150°C or 302°F) When this temperature is reached and after the ALd delay time the HA alarm is enabled.
ALL	Low temperature alarm setting: (ALC = rE, 0 to 50 °C or 90°F / ALC = Ab, - 55°C or - 67°F to ALU) When this temperature is reached and after the ALd delay time, the LA alarm is enabled.
AHy	Differential for temperature alarm: (0.1°C to 25.5°C / 1°F to 45°F) Intervention differential for recovery of temperature alarm.
ALd	Temperature alarm delay: (0 to 255 minutes) Time interval between the detection of an alarm condition and the corresponding alarm signaling.
rA2	Probe for second temperature alarm: (nP - P1 - P2 - P3 - P4 - P5 – tEr) It selects the probe used to signal alarm temperature.
A2U	Second high temperature alarm setting: (A2L to 150°C or 302°F) When this temperature is reached and after the A2d delay time the HA2 alarm is signaled.

Table 16-1 - Parameter List

Parameter	Description
A2L	Second Low temperature alarm setting: (- 55°C or - 67°F to A2U) When this temperature is reached and after the A2d delay time, the LA2 alarm is signaled.
A2H	Differential for second temperature alarm: (0.1°C to 25.5°C / 1°F to 45°F) Intervention differential for recovery of second temperature alarm.
Ad2	Second temperature alarm delay: (0 to 255 minutes) Time interval between the detection of second temperature alarm condition and the corresponding alarm signaling.
dAO	Delay of temperature alarm at start-up: (0 minutes to 23 hours, 50 minutes) Time interval between the detection of the temperature alarm condition after the instrument power on and the alarm signaling.
EdA	Alarm delay at the end of defrost: (0 to 255 minutes) Time interval between the detection of the temperature alarm condition at the end of defrost and the alarm signaling.
dot	Temperature alarm exclusion after door open: (0 to 255 minutes)
Sti	Stop regulation interval (Only XM679K): (0.0 to 24.0 hours: tens of minutes) After regulating continuously for Sti time, the valve closes for Std time in order to prevent ice creation.
Std	Stop duration (Only XM679K): (0 to 60 minutes) It defines stop regulation time after Sti.
tbA	Disabling alarm relay by pressing a key: (N; Y)
OPTIONAL OUTPUT (only for XM679K)	
oA5	Relay at term. 1-2-3 configuration: (nP – CPr -CP2- -dEF-Fan-ALr-LiG-AUS-Htr-OnF - AC): nP = not used; CPr= relay works as a compressor or solenoid valve relay; CP2= relay works as second dEF= relay works as defrost relay; Fan= relay works as a Fan relay; ALr= activation with alarm conditions; LiG= light activation; AUS= auxiliary relay, it can be switched ON/OFF also by key; Htr = deadband regulation (not compatible with CrE=y); OnF= ON/OFF functioning, AC = anti-sweat heaters.
oA6	Relay at term. 17-18 configuration: nP – CPr -CP2- -dEF-Fan-ALr-LiG-AUS-Htr-OnF - AC): nP = not used; CPr= relay works as a compressor or solenoid valve relay; CP2= relay works as second dEF= relay works as defrost relay; Fan= relay works as a Fan relay; ALr= activation with alarm conditions; LiG= light activation; AUS= auxiliary relay, it can be switched ON/OFF also by key; Htr = deadband regulation (not compatible with CrE=y); OnF= ON/OFF functioning, AC = anti-sweat heaters.
CoM	Type of functioning modulating output: <ul style="list-style-type: none"> • For models with PWM / O.C. output to PM5= PWM 50Hz; PM6= PWM 60Hz; OA7= not set it; • For models with 4 to 20mA / 0 to 10V output to Cur= 4 to 20mA current output; tEn= 0 to 10V voltage output.
AOP	Alarm relay polarity: cL= normally closed; oP= normally opened.
iAU	Auxiliary output is unrelated to ON/OFF device status: N= if the instrument is switched off also the auxiliary output is switched off; Y= the auxiliary output state is unrelated to the ON/OFF device status.
DIGITAL INPUTS	
i1P	Digital input 1 polarity: (cL – oP) CL: the digital input is activated by closing the contact; OP: the digital input is activated by opening the contact.
i1F	Digital input 1 function: (nu - EAL – bAL – PAL – dor – dEF – AUS – LiG – OnF – Htr – FHU – ES – HdY) nu = not used; EAL= external alarm; bAL= serious external alarm; PAL= pressure switch activation; dor= door open; dEF= defrost activation; AUS= auxiliary activation; LiG= light activation; OnF= switch on/off the instrument; FHU= not used; ES= activate energy saving; nt = second map enabling; cLn = clean function dEn = defrost off, CP1 = compressor 1 safety, CP2 = compressor 2 safety.
d1d	Time interval/delay for digital input alarm: (0 to 255 minutes) Time interval to calculate the number of the pressure switch activation when i1F=PAL. If i1F=EAL or bAL (external alarms), “d1d” parameter defines the time delay between the detection and the successive signaling of the alarm. If i1F=dor this is the delay to activate door open alarm.
i2P	Digital input 2 polarity: (cL – oP) CL: the digital input is activated by closing the contact; OP: the digital input is activated by opening the contact.

Table 16-1 - Parameter List

Parameter	Description
i2F	Digital input 2 function: (nu - EAL - bAL - PAL - dor - dEF - AUS - LiG - OnF - Htr - FHU - ES - Hdy) nu = not used; EAL= external alarm; bAL= serious external alarm; PAL= pressure switch activation; dor= door open; dEF= defrost activation; AUS= auxiliary activation; LiG= light activation; OnF= switch on/off the instrument; FHU= not used; ES= activate energy saving; nt = second map enabling; cLn = clean function dEn = defrost off, CP1 = compressor 1 safety, CP2 = compressor 2 safety.
d2d	Time interval/delay for digital input alarm: (0 to 255 minutes) Time interval to calculate the number of the pressure switch activation when i2F=PAL. If i2F=EAL or bAL (external alarms), "d2d" parameter defines the time delay between the detection and the successive signaling of the alarm. If i2F=dor this is the delay to activate door open alarm.
i3P	Digital input 3 polarity: (cL - oP) CL: the digital input is activated by closing the contact; OP: the digital input is activated by opening the contact.
i3F	Digital input 3 function: (nu - EAL - bAL - PAL - dor - dEF - AUS - LiG - OnF - Htr - FHU - ES - Hdy) nu = not used; EAL= external alarm; bAL= serious external alarm; PAL= pressure switch activation; dor= door open; dEF= defrost activation; AUS= auxiliary activation; LiG= light activation; OnF= switch on/off the instrument; FHU= not used; ES= activate energy saving; nt = second map enabling; cLn = clean function dEn = defrost off, CP1 = compressor 1 safety, CP2 = compressor 2 safety.
d3d	Time interval/delay for digital input alarm: (0 to 255 minutes) Time interval to calculate the number of the pressure switch activation when i3F=PAL. If i3F=EAL or bAL (external alarms), "d3d" parameter defines the time delay between the detection and the successive signaling of the alarm. If i3F=dor this is the delay to activate door open alarm.
nPS	Pressure switch number: (0 to 15) Number of activation of the pressure switch, during the "d#d" interval, before signaling the alarm event (i2F= PAL). If the nPS activation in the did time is reached, switch off and on the instrument to restart normal regulation.
odc	Compressor and fan status when open door: no = normal; Fan = Fan OFF; CPr = Compressor OFF; F_C = Compressor and fan OFF.
rrd	Outputs restart after doA alarm: No = outputs not affected by the doA alarm; Yes = outputs restart with the doA alarm.
RTC SUBMENU (if present)	
CbP	Clock Presence (N to Y): It permits to disable or enable the clock.
Hur	Current hour (0 to 23 hours)
Min	Current minute (0 to 59 minutes)
dAY	Current day (Sun to Sat)
Hd1	First weekly holiday (Sun to nu) Set the first day of the week that follows the holiday times.
Hd2	Second weekly holiday (Sun to nu) Set the second day of the week that follows the holiday times.
Hd3	Third weekly holiday (Sun to nu) Set the third day of the week that follows the holiday times.
ILE	Energy Saving cycle start during workdays: (0 to 23 hours, 50 minutes) During the Energy Saving cycle the setpoint is increased by the value in HES so that the operation setpoint is SET + HES.
dLE	Energy Saving cycle length during workdays: (0 to 24 hours 00 minutes) Sets the duration of the Energy Saving cycle on workdays.
ISE	Energy Saving cycle start on holidays. (0 to 23 hours 50 minutes)
dSE	Energy Saving cycle length on holidays (0 to 24 hours 00 minutes)
HES	Temperature increase during the Energy Saving cycle (-30 to 30°C / -54 to 54°F) Sets the increasing value of the setpoint during the Energy Saving cycle.
Ld1 to Ld6	Workday defrost start (0 to 23 hours 50 minutes) These parameters set the beginning of the 6 programmable defrost cycles during workdays. Ex. When Ld2 = 12.4 the second defrost starts at 12.40 during workdays.
Sd1 to Sd6	Holiday defrost start (0 to 23 hours 50 minutes) These parameters set the beginning of the 6 programmable defrost cycles on holidays. Ex. When Sd2 = 3.4 the second defrost starts at 3.40 on holidays.

Table 16-1 - Parameter List

Parameter	Description
ENERGY SAVING	
HES	Temperature increase during the Energy Saving cycle: (-30 to 30°C / -54 to 54°F) sets the increasing value of the setpoint during the Energy Saving cycle.
PEL	Energy saving activation when light is switched off: (N to Y) N= function disabled; Y= energy saving is activated when the light is switched off and vice versa.
LAN MANAGEMENT	
LMd	Defrost synchronization: Y= the section send a command to start defrost to other controllers, N= the section that will not send a global defrost command.
dEM	Type of end defrost: N= the of the LAN defrost are independent; Y= the end of the defrost are synchronization.
LSP	L.A.N. setpoint synchronization: Y= the section setpoint, when modified, is updated to the same value on all the other sections; N= the setpoint value is modified only in the local section.
LdS	L.A.N. display synchronization: Y= the value displayed by the section is sent to all the other sections; N= the setpoint value is modified only in the local section.
LOF	L.A.N. On/Off synchronization this parameter states if the On/Off command of the section will act on all the other ones too: Y= the On/Off command is sent to all the other sections; N= the On/Off command acts only in the local section.
LLi	L.A.N. light synchronization this parameter states if the light command of the section will act on all the other ones too: Y= the light command is sent to all the other sections; N= the light command acts only in the local section.
LAU	L.A.N. AUX output synchronization this parameter states if the AUX command of the section will act on all the other ones too: Y= the light command is sent to all the other sections; N= the light command acts only in the local section.
LES	L.A.N. energy saving synchronization this parameter states if the energy saving command of the section will act on all the other ones too: Y= the Energy Saving command is sent to all the other sections; N= the Energy Saving command acts only in the local section.
LSD	Remote probe display: this parameter states if the section has to display the local probe value or the value coming from another section: Y= the displayed value is the one coming from another section (that has parameter LdS = y); N= the displayed value is the local probe one.
LPP	Remote pressure probe: N= the value of pressure probe is read from local probe; Y= the value of pressure probe is sent via LAN.
LCP	P4 probe sent via LAN (N,Y)
StM	Solenoid activation via LAN: N= not used; Y= a generic cooling requests from LAN activate the solenoid valve connected to compressor relay.
ACE	Cold Calling in LAN always enabled even if the compressor block: (N,Y)
PROBE CONFIGURATION	
P1C	Probe 1 configuration: (nP – PtC – ntc – PtM) nP= not present; PtC= PtC; ntc= NTC; PtM= Pt1000
OF1	Probe 1 calibration: (-12.0 to 12.0°C/ -21 to 21°F) allows to adjust possible offset of the thermostat probe.
P2C	Probe 2 configuration: (nP – PtC – ntc – PtM) nP= not present; PtC= PtC; ntc= NTC; PtM= Pt1000.
OF2	Probe 2 calibration: (-12.0 to 12.0°C/ -21 to 21°F) allows to adjust possible offsets of the evaporator probe.
P3C	Probe 3 configuration: (nP – PtC – ntc – PtM) nP= not present; PtC= PtC; ntc= NTC; PtM= Pt1000.
OF3	Probe 3 calibration: (-12.0 to 12.0°C/ -21 to 21°F) allows to adjust possible offset of the probe 3.
P4C	Probe 4 configuration: (nP – PtC – ntc – PtM) nP= not present; PtC= PtC; ntc= NTC; PtM= Pt1000.
OF4	Probe 4 calibration: (-12.0 to 12.0°C/ -21 to 21°F) allows to adjust possible offset of the probe 4.
P5C	Probe 5 configuration: (nP – PtC – ntc – PtM – 420 – 5Vr) nP= not present; PtM= Pt1000; 420= 4 to 20mA; 5Vr= 0 to 5V ratiometric; (Only XM679K)

Table 16-1 - Parameter List

Parameter	Description
OF5	Probe 5 calibration: (-12.0 to 12.0°C/ -21 to 21°F) allows to adjust possible offset of the probe 5. (Only XM679K)
P6C	Probe 6 configuration: (nP – Ptc – ntc – PtM) nP= not present; PtC= Ptc; ntc = NTC; PtM= Pt1000; (Only XM679K)
OF6	Probe 6 calibration: (-12.0 to 12.0°C/ -21 to 21°F) Allows to adjust possible offset of the probe 6. (Only XM679K)
PA4	Probe value at 4mA or At 0V: (-1.0 to P20 bar / -14 to PSI / -10 to P20 kPA * 10) pressure value measured by probe at 4mA or at 0V (related to PrM parameter) Referred to Pb5.
P20	Probe value 20mA or At 5V: (PA4 to 50.0 bar / 725 psi / 500 kPA * 10) pressure value measured by probe at 20mA or at 5V (related to PrM parameter) Referred to Pb5.
SERVICE – OTHERS	
LCL	Light on during cleaning mode (N,Y)
FCL	Fan on during cleaning mode (N,Y)
MAP	Map used during standard operation (1°M, 2°M, 3°M, 4°M) It sets the map used by the controller among the four possible maps.
MP1	Alternate Map enabled by digital input or MODBUS command (1°M, 2°M, 3°M, 4°M) It sets the alternate map enabled by digital input or MODBUS command among the four possible maps.
CLt	Cooling time percentage: it shows the effective cooling time calculated by XM600 during regulation.
tMd	Time to next defrost: it shows time before the next defrost if interval defrost is selected.
LSn	L.A.N. section number (1 to 8) Shows the number of sections available in the L.A.N.
Lan	L.A.N. serial address (1 to LSn) Identifies the instrument address inside local network of multiplexed cabinet controller.
Adr	RS485 serial address (1 to 247): Identifies the instrument address when connected to a MODBUS compatible monitoring system.
br	It sets the baud rate among: (96 = 9.6 bit/s; 192 = 19.2 bit/s)
EMU	Previous versions emulation (2V8, 3V8, 4V2) It allows the controller to be used in a LAN of controllers with previous versions: 2V8 = It emulates version 2.8 3V8 = It emulates version 3.8 4V2 = It emulates version 4.2
rEL	Release software: (read only) Software version of the microprocessor.
SrL	Software sub-release: (read only) For internal use.
Ptb	Parameter table: (read only) It shows the original code of the Emerson parameter map.
Pr2	Access to the protected parameter list (read only).

Table 16-1 - Parameter List

17 Digital Inputs

The XM600 series can support up to 3 free of voltage contact configurable digital inputs (depending on the models). They are configurable via i#F parameter

17.1. Generic Alarm (EAL)

As soon as the digital input 1, 2, or 3 is activated the unit will wait for “**d1d**” or “**d2d**” or “**d3d**” time delay before signaling the “**EAL**” alarm message. The outputs status do not change. The alarm stops just after the digital input is deactivated.

17.2. Serious Alarm Mode (BAL)

When the digital input is activated, the unit will wait for “d1d” or “d2d” or “d3d” delay before signaling the “BAL” alarm message. The relay outputs are switched OFF. The alarm will stop as soon as the digital input is deactivated.

17.3. Pressure Switch (PAL)

If during the interval time set by “d1d” or “d2d” or “d3d” parameter, the pressure switch has reached the number of activation of the “nPS” parameter, the “CA” pressure alarm message will be displayed. The compressor and the regulation are stopped. When the digital input is ON the compressor is always OFF. **If the nPS activation in the d#d time is reached, switch off and on the instrument to restart normal regulation.**

17.4. Door Switch Input (dor)

It signals the door status and the corresponding relay output status through the “odc” parameter: **no** = normal (any change); **Fan** = Fan OFF; **CPr** = Compressor OFF; **F_C** = Compressor and fan OFF. Since the door is opened, after the delay time set through parameter “d#d”, the door alarm is enabled, the display shows the message “dA” and **the regulation restarts after rrd time.** The alarm stops as soon as the external digital input is disabled again. With the door open, the high and low temperature alarms are disabled.

17.5. Start Defrost (DEF)

It executes a defrost if there are the right conditions. After the defrost is finished, the normal regulation will restart only if the digital input is disabled otherwise the instrument will wait until the “Mdf” safety time is expired.

17.6. Relay Aux Actuation (AUS)

This function allows to turn ON and OFF the auxiliary relay by using the digital input as external switch.

17.7. Relay Light Actuation (LIG)

This function allows to turn ON and OFF the light relay by using the digital input as external switch.

17.8. Remote ON/OFF (ONF)

This function allows the instrument to switch ON and OFF.

17.9. FHU – Not Used

This function allows the kind of regulation to be changed from cooling to heating and vice versa.

17.10. Energy Saving Input (ES)

The Energy Saving function allows to change the setpoint value as the result of the SET+ HES (parameter) sum. This function is enabled until the digital input is activated.

17.11. Cleaning Function Activation (CLN)

In this configuration, the digital input activates the CLEANING function. It can be activated only if the device is ON.

This function has the following characteristics:

- The display visualizes the “CLn” label
- The light status depends on the LCL parameter (No/Yes), however the light can be modified both via button and MODBUS command.
- The fan’s status depends on the FCL parameter (No/Yes), furthermore they are not thermo-regulated (par.FST).

The “CLEANING MODE” MODBUS command has higher priority compared to the digital input.

17.12. Defrost End (DEN)

The digital input ends the defrost cycle in progress. The drip time will follow the defrost end. A further defrost request with the digital input active will not be managed.

17.13. Digital Inputs Polarity

The digital inputs polarity depends on “I#P” parameters: **CL**: the digital input is activated by closing the contact; **OP**: the digital input is activated by opening the contact.

18 Use of the Programming Hot Key



XM controllers can download or upload the parameter list from its own internal memory to the Hot Key and vice-versa through a TTL connector.

Figure 18-1 - Hot Key

18.1. Download (From the Hotkey to the Device)

1. Turn OFF the controller by pressing the on/off button (⏻) for five (5) seconds. **OFF** will display. Insert the Hot Key into the 5-pin connector labeled **HOT-KEY**, and then turn the controller back ON by pressing the on/off button again for five (5) seconds. The normal temperature value will display to indicate the controller is ON.
2. The parameter list of the Hot Key is downloaded into the controller memory automatically and **doL** will display. After 10 seconds, the controller will start working with the new parameters.
3. **End** will display at the end of the data transfer phase if the controller is programmed correctly. **Err** will display if there is an error or failure in programming.
 - **End** = Correct programming. This means the controller will start regularly with the new programming.
 - **Err** = Failed programming. In this case, turn the controller OFF and then ON if you want to restart the download again or remove the Hot Key to abort the operation.
4. Remove the Hot-Key.

NOTE: The procedure may fail if the firmware version and the controller models are different.

18.2. Upload (From the Device to the Hotkey)

1. When the XM controller is ON, insert the Hot Key into the 5-pin connector labeled **HOT-KEY**.
2. Press and release the up arrow button.
3. The upload will begin, and **UPL** will blink on the display. **End** will display at the end of the data transfer phase if a successful upload has occurred. **Err** will display if there is an error or failure in programming.
 - **End** = Correct programming.
 - **Err** = Failed programming. In this case, press the **SET** key if you want to restart the programming again or remove the unprogrammed Hot-Key.
4. Remove the Hot Key.

NOTE: The upload procedure will overwrite everything previously uploaded from the last Hot Key upload.

19 Technical Data

CX660 KEYBOARD	
Housing	Self-extinguishing ABS
Dimensions	Case: CX660 fascia Front: 35 mm x 77 mm Depth: 18 mm
	Panel Mount: 29 mm x 71 mm panel cut-out
Protection	IP20
	Frontal: IP65
Power Supply	From XM600K power module
Display	Three (3) digits, red LED, 14.2 mm high
Optional Output	Buzzer
POWER MODULES	
Case	8 DIN
Connections	Screw terminal block $\leq 1.6 \text{ mm}^2$ heat-resistant wiring and 5.0 mm Faston or screw terminals
Power Supply	Depending on the model 12Vac – 24Vac - 110Vac to 10% - 230Vac to 10% or 90 to 230Vac with switching power supply.
Power Absorption	9VA max
Inputs	Up to 6 NTC/PTC/Pt1000 probes
Digital Inputs	Three (3) voltage-free
Relay Outputs (<u>Total current on loads MAX 16A</u>)	Solenoid Valve: relay SPST 5(3)A, 250Vac Defrost: relay SPST 16A, 250Vac Fan: relay SPST 8A, 250Vac Light: relay SPST 16A, 250Vac Alarm: SPDT relay 8A, 250Vac Aux: SPST relay 8A, 250Vac
Valve Output	A.c. output from 10W up to 30W
Optional Output (AnOUT) Depending on the model	PWM/ Open Collector outputs: PWM or 12VDC max 40mA
	Analog Output: 4 to 20mA or 0 to 10V
Serial Output	RS485 with MODBUS-RTU and LAN
Data Storing	On the volatile memory (EEPROM)
Kind of Action	1B
Pollution Degree	2
Software Class	A
Operating Temperature	32 to 140°F (0 to 60°C)
Storage Temperature	-13 to 140°F (-25°C to 60°C)
Relative Humidity	20 to 85% (no condensing)
Measuring and Regulation Range	NTC probe: -58 to 230°F (-40 to 110°C)
	PTC probe: -67 to 302°F (-50 to 150°C)
	Pt1000 probe: -148 to 212°F (-100 to 100°C)
Resolution	1°C or 1°F or 0.1°C (selectable)

Table 19-1- XM679K Technical Specifications

20 Default Setting Values

Label	M1	M2	M3	M4	Menu	Parameters Description
rtc	---				Pr1	Access by RTC submenu
EEU	---				Pr1	Access by RTC submenu
SEt	2.0	2.0	2.0	2.0	---	Setpoint
SEC	LOC				---	LAN mode selection: Local or Global
Hy	2.0	2.0	2.0	2.0	Pr1	Differential
int	150	150	150	150	Pr2	Integral time for room temperature regulation
CrE	n				Pr2	Continuous regulation activation
LS	-30	-30	-30	-30	Pr2	Minimum setpoint
US	10	10	10	10	Pr2	Maximum setpoint
odS	1				Pr2	Outputs activation delay at start up
AC	0				Pr2	Anti-short cycle delay
CCt	0.0				Pr2	Continuous cycle duration
CCS	2.0				Pr2	Continuous cycle setpoint
Con	5				Pr2	Compressor ON time with faulty probe
CoF	10				Pr2	Compressor OFF time with faulty probe
CF	°C				Pr2	Measurement unit: Celsius, Fahrenheit
PrU	rE				Pr2	Pressure Mode
PMU	bAr				Pr2	Pressure measurement unit
PMd	PrE				Pr2	Pressure displaying mode: temperature or pressure
rES	dE				Pr2	Resolution (only C): decimal, integer
Lod	P1				Pr2	Local display: default display
rEd	P1				Pr1	Remote display: default display
dLy	0				Pr2	Display delay
rPA	P1				Pr2	Regulation probe A
rPb	nP				Pr2	Regulation probe B
rP3	nP				Pr2	Regulation probe 3
rP4	nP				Pr2	Regulation probe 4
rP5	nP				Pr2	Regulation probe 5
rPd	rPA				Pr2	Temperature Regulation Strategy
rPE	100				Pr2	Virtual probe percentage (rPd=rAb)
Fty	448				Pr2	Refrigerant gas type
ATU	n	y	n	y	Pr2	Regulator auto tuning
AMS	n	n	n	n	Pr2	Min Superheat search
SSH	6.0	6.0	6.0	6.0	Pr2	Superheat setpoint
SHy	0.0	0	0	0	Pr2	Differential for low superheat function
Pb	8	8	8	8	Pr2	Regulation proportional band
PbH	0.2	0.2	0.2	0.2	Pr2	Dead band for superheat regulation
rS	0	0.0	0.0	0.0	Pr2	Band Offset

Table 20-1 - Default Setting Values

Label	M1	M2	M3	M4	Menu	Parameters Description
inC	220	220	220	220	Pr2	PID integration time
dFC	1	1	1	1	Pr2	PID derivation constant time
PEd	On				Pr2	Delay before stopping regulation with probe error
PEO	50				Pr2	Probe Error opening percentage
SFd	0.3				Pr2	Duration of Soft Start phase
SFP	40.0				Pr2	Open percentage for soft start phase
OHG	45.0	45.0	45.0	45.0	Pr2	Open percentage for inversion defrost
Pdd	0.4				Pr2	Duration for post defrost phase
OPd	50.0				Pr2	Open percentage for post defrost phase
LnF	10.0	10.0	10.0	10.0	Pr2	Minimum open percentage for stepper valve
MnF	100	100	100	100	Pr2	Maximum open percentage for stepper valve
dCL	0				Pr2	Regulation off delay, when the setpoint is reached 2
Fot	nu				Pr2	Enable for forcing open valve to a fixed value
LPL	-0.5				Pr2	Minimum value threshold of pressure for regulation
MOP	4.5	4.5	4.5	4.5	Pr2	Maximum value threshold of suction pressure
dMP	10				Pr2	Delay for high pressure alarm activation (MOP)
LOP	-0.5	-0.5	-0.5	-0.5	Pr2	Minimum value threshold of suction pressure
dLP	10				Pr2	Delay for low pressure alarm activation (LOP)
dML	2.0	2.0	2.0	2.0	Pr2	Opening steps variation during MOP and LOP
AAS	n				Pr2	Low superheat alarm with "XeCO2 function active
HSH	60				Pr2	Threshold for maximum superheat alarm
LSH	2				Pr2	Threshold for minimum superheat alarm
dHS	0.3				Pr2	Delay for high superheat alarm
dLS	0.3				Pr2	Delay for low superheat alarm
LSA	1.0				Pr2	Subtracting percentage with low superheat alarm
FrC	50				Pr2	Additional integration constant for fast recovery
AnP	3	3	3	3	Pr2	Number of average value for converted temperature (pressure)
Ant	1	1	1	1	Pr2	Number of average value for temperature
SLb	1	1	1	1	Pr2	Reaction time (interval for valve PID management)
CYP	6				Pr2	Cycle period for ON/OFF valve
dPA	Pr2				Pr2	Defrost probe A
dPb	Pr2				Pr2	Defrost probe B
tdF	EL	EL	EL	EL	Pr2	Kind of defrost: air, resistors, inversion
EdF	in				Pr2	Defrost mode: Clock or interval
Srt	150				Pr2	Differential for heater
Hyr	2.0				Pr2	Time out for heater (if temp > Srt)
tod	255				Pr2	Defrost with two probes
d2P	n	n	n	n	Pr2	Defrost with two probes
dtE	8.0	8.0	8.0	8.0	Pr2	First defrost termination temperature
dtS	8.0	8.0	8.0	8.0	Pr2	Second defrost termination temperature

Table 20-1 - Default Setting Values

Label	M1	M2	M3	M4	Menu	Parameters Description
idF	6	6	6	6	Pr2	Interval between defrosts
idE	y				Pr2	Storage in EEPROM defrost interval
ndt	3	3	3	3	Pr2	Minimum Defrost Time
MdF	30	30	30	30	Pr2	Maximum defrost duration
dSd	0				Pr2	Delay for defrost on call
dFd	it				Pr2	Visualization during defrost
dAd	30				Pr2	Visualization delay for temperature after defrost
Fdt	0	0	2	2	Pr2	Dripping time
dPo	n				Pr2	Defrost at power ON
dAF	0				Pr2	Delay defrost after freezing
Pdt	F-C				Pr2	Pump down type
Pdn	0				Pr2	Pump down duration
Ctd	6	6	6	6	Pr2	Differential for defrost start
nbd	4.0	4.0	4.0	4.0	Pr2	Minimum Compressor run time before defrost
Mdb	16.0	16.0	16.0	16.0	Pr2	Maximum Compressor run time before defrost
nct	-30	-30	-30	-30	Pr2	Minimum coil temperature to trigger a defrost
FAP	P2				Pr2	Fan probe A
FnC	O-y	o-y	o-n	o-n	Pr2	Fan operating mode
Fnd	0	0	5	5	Pr2	Fan delay after defrost
FCt	10				Pr2	Temperature differential to avoid short cycles of fans
FSt	15.0	15.0	2.0	2.0	Pr2	Fan stop temperature
FHy	1.0				Pr2	Fan stop hysteresis
tFE	n				Pr2	Fan regulation by temperature in defrost
Fod	0				Pr2	Fan activation time after defrost (without compressor)
Fon	0				Pr2	Fan ON time
FoF	0				Pr2	Fan OFF time
trA	UAL				Pr2	Kind of regulation with PWM output
SOA	0				Pr2	Fixed speed for fan
SdP	30.0				Pr2	Default Dewpoint value
ASr	1.0				Pr2	Differential for fan / offset for anti-sweat heater
PbA	5.0				Pr2	Proportional band for modulating output
AMi	0				Pr2	Minimum output for modulating output
AMA	100				Pr2	Maximum output for modulating output
AMt	3				Pr2	1:Time with fan at maximum speed 2:The control period for the anti-sweat control
rAL	tEr				Pr2	Probe for temperature alarm
ALC	Ab				Pr2	Temperature alarm configuration: relative / absolute
ALU	10	10	10	10	Pr2	High temperature alarm setting
ALL	-30	-30	-30	-30	Pr2	Low temperature alarm setting
AHy	1.0				Pr2	Differential for temperature alarm

Table 20-1 - Default Setting Values

Label	M1	M2	M3	M4	Menu	Parameters Description
ALd	15	15	15	15	Pr2	Temperature alarm delay
rA2	nP				Pr2	Probe for temperature alarm 2
A2U	150	150	150	150	Pr2	High temperature alarm 2 setting
A2L	-40	-40	-40	-40	Pr2	Low temperature alarm 2 setting
A2H	2				Pr2	Differential for temperature alarm 2
A2d	15	15	15	15	Pr2	Temperature alarm delay 2
dAO	1.0	1.0	1.0	1.0	Pr2	Delay of temperature alarm at start-up
EdA	60				Pr2	Alarm delay at the end of defrost
dot	30				Pr2	Temperature alarm exclusion after door open
Sti	nu	nu	nu	nu	Pr2	Time for compressor ON before regulation break
Std	10	3	3	3	Pr2	Time for compressor OFF for regulation break
tbA	n				Pr2	Silencing alarm relay with buzzer
oA5*	ALr				Pr2	Relay 5 configuration
oA6*	AUS				Pr2	Relay 6 configuration
CoM	420				Pr2	Modulating output configuration
AOP	CL				Pr2	Alarm relay polarity
iAU	n				Pr2	Auxiliary output independent from ON/OFF state
i1P	cL				Pr2	Digital input 1 polarity
i1F	dor				Pr2	Digital input 1 configuration
d1d	15				Pr2	Digital input 1 activation delay
i2P	cL				Pr2	Digital input 2 polarity
i2F	LiG				Pr2	Digital input 2 configuration
d2d	5				Pr2	Digital input 2 activation delay
i3P	cL				Pr2	Digital input 3 polarity
i3F	ES				Pr2	Digital input 3 configuration
d3d	0				Pr2	Digital input 3 activation delay
nPS	15				Pr2	Pressure switch number
OdC	F-C				Pr2	Compressor and fan status when open door
rrd	30				Pr2	Outputs restart after door open alarm
CbP	y				Pr2	Clock presence
Hur	---				Pr1	Current hour
Min	---				Pr1	Current minutes
dAY	---				Pr1	Current day
Hd1	nu				Pr1	First weekly day
Hd2	nu				Pr1	Second weekly day
Hd3	nu				Pr1	Third weekly day
ILE	0.0				Pr1	Energy saving cycle start during workdays
dLE	0.0				Pr1	Energy saving cycle length during workdays
ISE	0.0				Pr1	Energy saving cycle start during holidays
dSE	0.0				Pr1	Energy saving cycle length during holidays

Table 20-1 - Default Setting Values

Label	M1	M2	M3	M4	Menu	Parameters Description
HES		0.0			Pr2	Temperature increasing during Energy Saving
Ld1		6.0			Pr1	Workdays First defrost start
Ld2		13.0			Pr1	Workdays Second defrost start (minimum as Ld1)
Ld3		21.0			Pr1	Workdays Third defrost start (minimum as Ld2)
Ld4		nu			Pr2	Workdays Fourth defrost start (minimum as Ld3)
Ld5		nu			Pr2	Workdays Fifth defrost start (minimum as Ld4)
Ld6		nu			Pr2	Workdays Sixth defrost start (minimum as Ld5)
Sd1		6.0			Pr1	Holidays First defrost start
Sd2		13.0			Pr1	Holidays Second defrost start
Sd3		21.0			Pr1	Holidays Third defrost start
Sd4		nu			Pr1	Holidays Fourth defrost start
Sd5		nu			Pr1	Holidays Fifth defrost start
Sd6		nu			Pr1	Holidays Sixth defrost start
HES		0.0			Pr2	Temperature increasing during Energy Saving
PEL		n			Pr2	Energy saving activation when Light switched off
LMd		y			Pr2	Defrost Synchronization
dEM		y			Pr2	Defrost end Synchronization
LSP		n			Pr2	Setpoint Synchronization
LdS		n			Pr2	Display Synchronization (temperature sent via LAN)
LOF		n			Pr2	ON/OFF Synchronization
LLi		y			Pr2	Light Synchronization
LAU		n			Pr2	AUX Synchronization
LES		n			Pr2	Energy Saving Synchronization
LSd		n			Pr2	Remote probe displaying
LPP		n			Pr2	Pressure value sent in LAN
LCP		n			Pr2	P4 probe sent via LAN
StM		n			Pr2	Cooling request from LAN enable compressor relay
ACE		n			Pr2	Cold Calling in LAN always enabled even if the compressor block
P1C		ntc			Pr2	P1 configuration
OF1		0.0			Pr2	P1 calibration
P2C		ntc			Pr2	P2 configuration
OF2		0.0			Pr2	P2 calibration
P3C		nu			Pr2	P3 configuration
OF3		0.0			Pr2	P3 calibration
P4C		nu			Pr2	P4 configuration
OF4		0.0			Pr2	P4 calibration
P5C		420			Pr2	P5 configuration
OF5		0.0			Pr2	P5 calibration
P6C		PtM			Pr2	P6 configuration
OF6		0.0			Pr2	P6 calibration

Table 20-1 - Default Setting Values

Label	M1	M2	M3	M4	Menu	Parameters Description
PA4		0.5			Pr2	Probe value at 4 mA or at 0V (probe P5)
P20		11.0			Pr2	Probe value at 20 mA or at 5V (probe P5)
LCL		y			Pr2	Light on during cleaning mode
FCL		y			Pr2	Fan on during cleaning mode
MAP		1°M			Pr2	Map selection
MP1		1°M			Pr2	Map selection loaded by digital input
Adr		1			Pr1	MODBUS address
br		96			Pr2	Baud Rate selection for MODBUS : 9600 or 19200
EMU		nu			Pr2	Emulation previous version: 2V8, 3V8, 4V2
rEL		5.4			Pr2	Release code firmware (only read)
SrL		-			Pr2	Sub-release firmware (only read)
Ptb		-			Pr2	Map EEPROM ID
Pr2		321			Pr1	Password

Table 20-1 - Default Setting Values

*XM679K only

*This document may be photocopied for personal use.
 Visit our website at www.climate.emerson.com for the latest technical documentation and updates.
 Join Emerson Technical Support on Facebook. <http://on.fb.me/WUQRnt>
 For Technical Support call 833-409-7505 or email ColdChain.TechnicalServices@Emerson.com*

The contents of this publication are presented for informational purposes only and they are not to be construed as warranties or guarantees, express or implied, regarding the products or services described herein or their use or applicability. Emerson reserves the right to modify the designs or specifications of such products at any time without notice. Responsibility for proper selection, use and maintenance of any product remains solely with the purchaser and end-user. ©2022 Emerson is a trademark of Emerson Electric Co.