

Solutions for Temperature and Humidity



Full touch controllers for hanging rooms,
aging and ice cream display cases

DIXELL™



EMERSON™



Full touch controllers for hanging rooms, aging and ice cream display cases

The innovative XH78T controller equipped with the Full Touch capacitive touchscreen, is ready to answer most needs of applications that require temperature and humidity regulation, such as meat hanging and aging rooms and ice cream display cases.

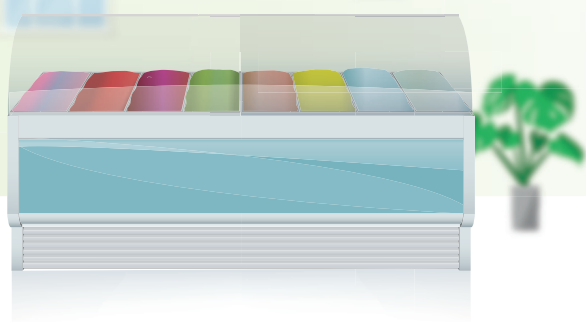
The XH78T is equipped with the latest technologies and in line with market trends. For example, its main features are variable speed fan management, high connectivity with supervisor and monitoring systems and advanced regulations (activation of timed sanitization cycles, management of the extractor fans, and more).



- Capacitive touch user interface
- Interactive and ultra-wide display
- Water and dust resistant
- Reduced learning curve through simplified navigation and common gestures



- Compatible with Low GWP Refrigerants
- Direct connection to local networks through Modbus protocol

Gesture

The innovative dynamic touch user interface allows the user to navigate in an intuitive and interactive way across the available functions. Interactivity and intuitiveness are enabled by gestures commonly used in smart devices. The new display with icons shows complete information about the status of the machine. The whole display area is used to interact with the device. Specific gestures are used to enable or disable functions, browse through screens and operational modes and modify the configuration of the device.



Tap and Hold

Activate / Deactivate / Save

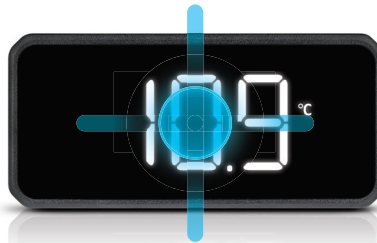

Swipe

Change Screen / Browse / Modify



One Tap

Switch ON / Switch OFF

One single controller for different values

One single display clearly visualizes temperature and humidity values. The new XH78T model implements a visualization mode that alternatively displays regulation values. According to what is required, it is possible to set the parameter to define a different visualization time both for temperature and humidity.

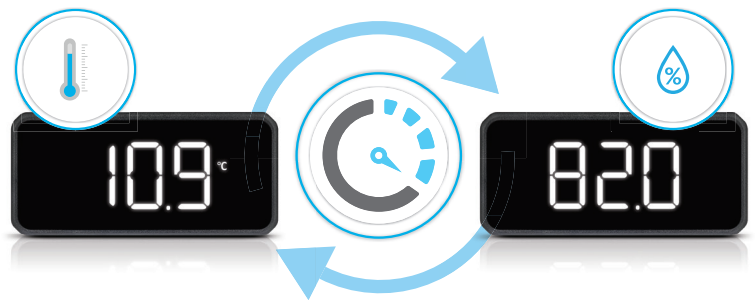

Data Management Cloud ready

The XH78T is compatible with the new “Data Management Cloud” service that allows the user to remotely access data on a Cloud platform through common mobile devices. The auto-detect system installed makes it possible to connect the controller and receive the application data automatically within a few minutes, resulting in time and cost reduction for the installation.

- Maintenance optimization avoiding unnecessary costs
- Optimized food preservation enabled by accurate reporting of all variables
- Data analysis for critical situations and waste detection



Applications

Because of its high-performance hardware and enhanced functions, the XH78T is ready to answer most needs of the applications currently on the market that require humidity control.

The controller can use 4÷20mA humidity probes like the XH20P model that ensures great precision, fast response, and supports up to 3 temperature NTC, PCT, or PT1000 probes. Each probe input can be configured independently. For example, this allows both NTC and PT1000 probes to be used simultaneously.

Below are three types of refrigerated cabinets where XH78T will find its perfect application.



Cold cuts aging cabinets

As essential assets for butcher and deli shops, these cabinets are the ideal solution for aging of cold cuts where humidity control is a fundamental factor.



Meat hanging cabinet

These cabinets allow meat to reach the appropriate aging point in a highly controlled and sanitized environment.

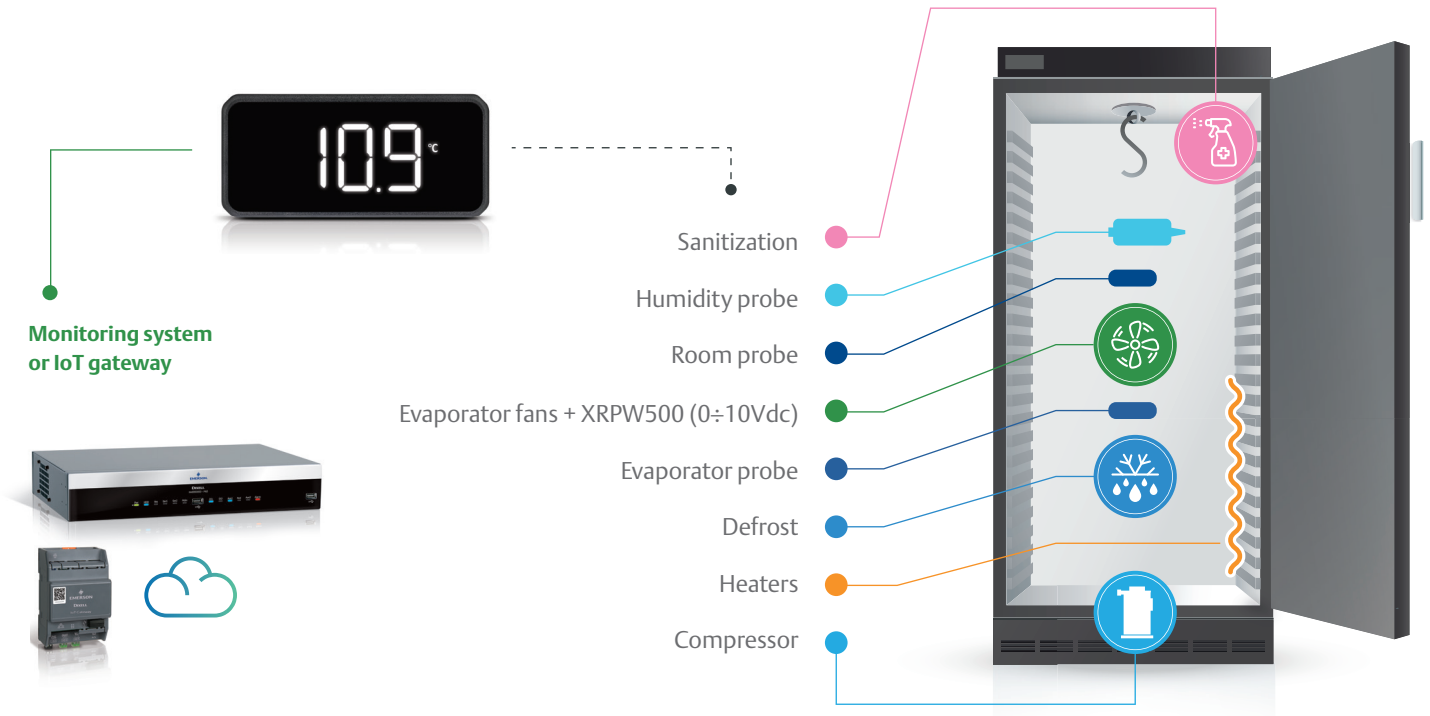

Ice cream display case

The precise control of temperature and humidity conditions is an essential feature to guarantee the quality of the product stored inside this kind of cases.

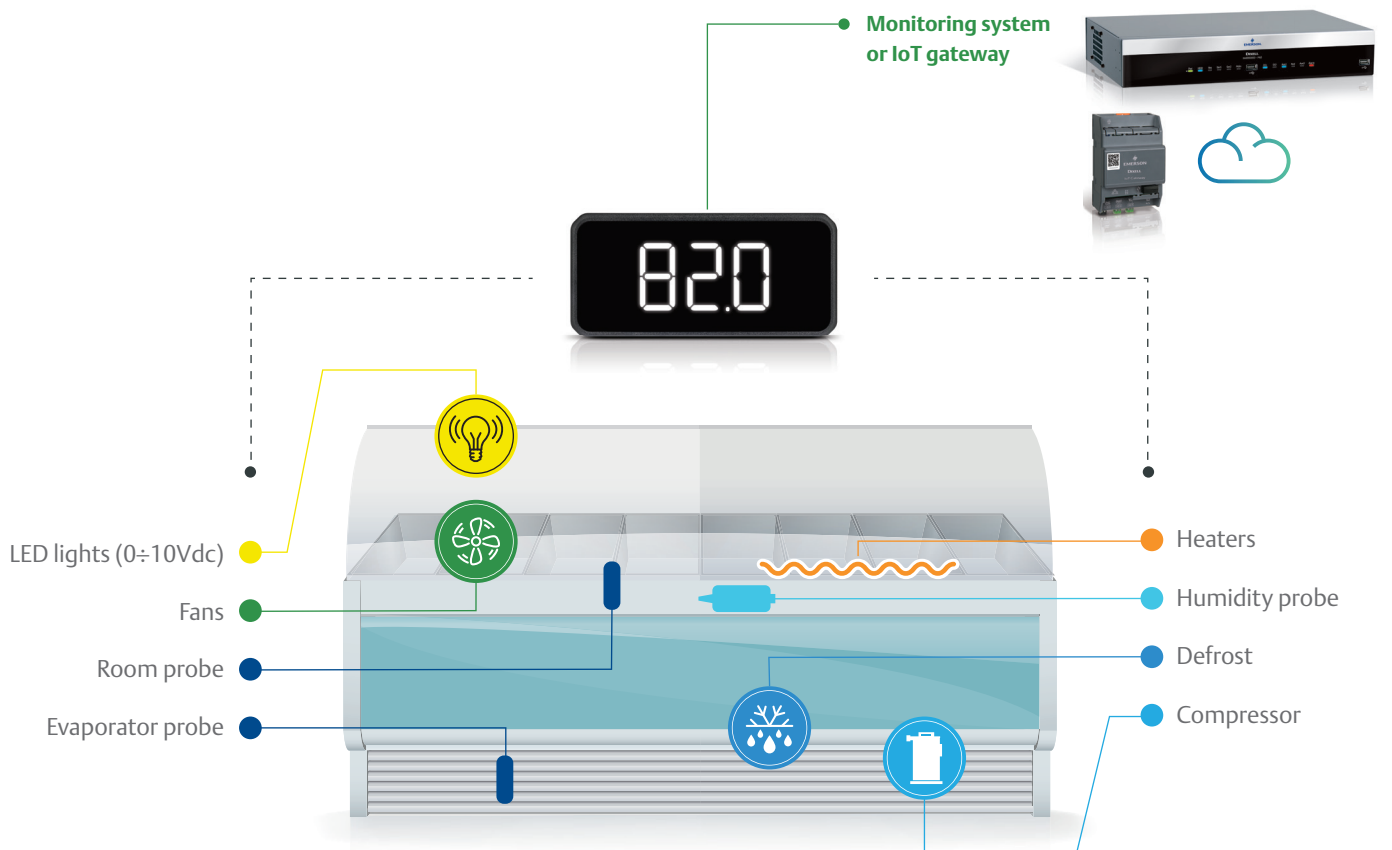

General functions

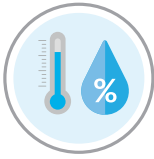

Temperature and humidity regulation

The XH78T model includes 5 different regulation modes that broaden the range of covered applications. It includes from the simplest to the most complex, ensuring an optimum management of all variables on site in every situation.



Sanitization function

It allows for control and elimination of bacteria present inside the storage cabinet, maintaining product quality, reducing odors, and decreasing use and exposure to detergents, disinfectants, and other chemical products, as well as complying with food preservation regulations.

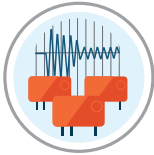

“Inrush” relè

It is available the version with 3 “inrush” relays that extend the life of the controller and allow loads to be used with lower energy consumption. This solution is highly valued for electrical fans, LED power supply, or compressors that require high peaks of current at power on.



Motion detector

The XH78T supports the X-MOD motion detector, which is a useful tool in terms of energy savings because it allows optimization of actions such as switching off the internal light, or modifying the fan speed of the evaporator according to the pre-set conditions determined during the configuration phase.



Environmentally friendly

With our eco-friendly solutions, innovation and efficiency means respecting the environment by optimizing consumption and reducing pollution, and gas emissions.



Counters

With the XH78T, analyzing the functioning of the device is even easier and more effective. Thanks to the counters installed it is now possible to identify any malfunction in advance, therefore allowing intervention before failures occur.



Double parameter map

Two parameter maps are available on XH78T; the user can select the most suitable for its application and quickly set parameters. The possibility to restore the factory default settings – a very useful operation in case of mistakes during the programming – allows automatic re-configuration of the controller to have it operating again for a subsequent and easier update.



Fan control

Advanced fan control allows proper temperature and humidity management, also through the optimization of air flow, resulting in proper preservation and ripening of food. It is possible to configure one of the digital and/or analog outputs to control the extractor fans.

Firmware update

It is possible to update the firmware of the controller by using the Wizmate software, directly on site, without replacing the controller and avoiding machine stops, which would result in wasted energy and resources.

Moreover, now available is the ability to adjust possible malfunctions in unusual operating conditions, and updating the controller with the latest available versions, enabling improved and extra functionality.

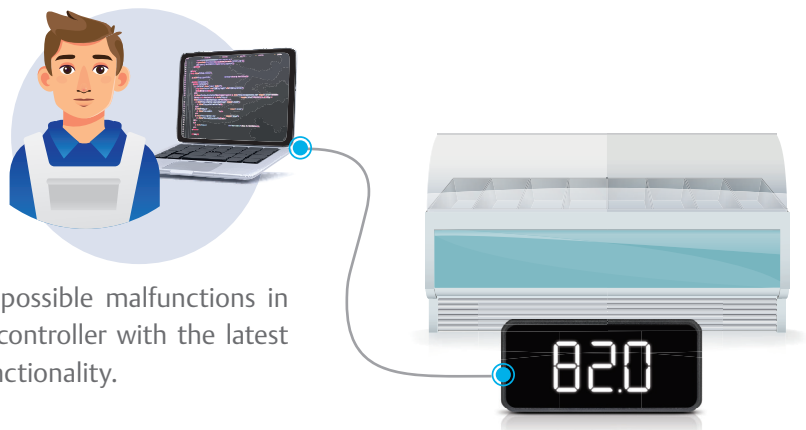

Features

	XH78T standard	XH78T with 1 inrush relay	XH78T with 3 inrush relays
Display	3 digits with decimal point and icons	3 digits with decimal point and icons	3 digits with decimal point and icons
Power Supply	100÷240Vac	100÷240Vac	100÷240Vac
Probe inputs*	3 x NTC/PTC/Pt1000 configurable + 1 x analog input	3 x NTC/PTC/Pt1000 configurable + 1 x analog input	3 x NTC/PTC/Pt1000 configurable + 1 x analog input
Digital inputs**	up to 2 x configurable	up to 2 x configurable	up to 2 x configurable
Relay outputs	16A SPST, 16A SPDT, 5A SPST, 5A SPDT all configurable	16A SPST, 16A SPDT, inrush 10A SPST, 5A SPDT all configurable	inrush 16A, 16A SPDT, inrush 10A SPST, inrush 10A SPST all configurable
Hot Key output	yes	yes	yes
0÷10Vdc output	optional	optional	optional
Serial output	RS485, 2 wires	RS485, 2 wires	RS485, 2 wires
Buzzer	yes, with configurable volume	yes, with configurable volume	yes, with configurable volume
Connectors	plug-in	plug-in	plug-in
Real Time Clock	optional	optional	optional

* Up to 3 if the digital input is configured as a probe input.

** Up to 2 digital inputs in the 2-temperature probe configuration.

Connections & dimensions

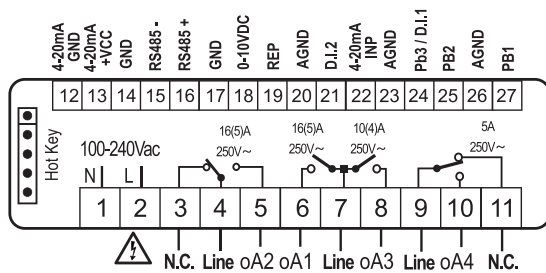

NOTE: in the version with inrush relay oA4 = inrush 10A

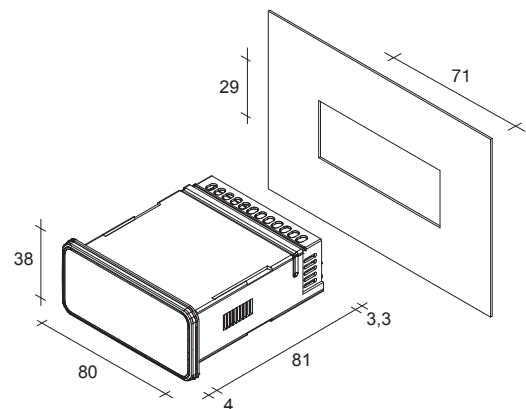

Accessories



XH-REP
Remote display



XJ485USB-KIT
Converter from USB to RS485



X-MOD 5V
Motion detector



WIZMATE
Programming tool for controllers
and Hot Key



HOT KEY 64K
Key for parameter
programming

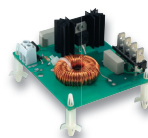

XRPW500
Fan speed controller for single-phase fan
speed regulation with 3A triac (700W)

Emerson Commercial & Residential Solutions

Dixell S.r.l. - Z.I. Via dell'Industria, 27 - 32016 Alpago (BL) ITALY - Tel. +39.0437.9833 r.a. - Fax +39.0437.989313
climate.emerson.com/en-gb/brands/Dixell - Dixell@Emerson.com

release 3.0 - 1582005500-GB

All trademarks are property of their respective owners. Dixell reserves the right to alter its products without notice. All rights reserved. Because environmental conditions are outside of Dixell's control, we cannot assume liability for results obtained nor any damages that may occur due to improper application. Manuals and updates are available on our Web Site EmersonClimate.com

EMERSON. CONSIDER IT SOLVED.™