

# Copeland Compressors and Condensing Units for Refrigeration Applications



Product Brochure  
2021 Edition

**COPELAND**

# About Copeland

We are a global climate technologies company engineered for sustainability. Today, we are building on our 100-year legacy through industry-leading innovation, putting Copeland at the forefront of positive change. We create sustainable residential, commercial and industrial spaces through HVACR technologies. We maintain the integrity of goods throughout the cold chain. And we bring comfort to people globally.

## Core Offerings

### Commercial Air Conditioning

Copeland offers the most advanced compression solutions creating cost-effective and comfortable indoor environments that meet requirements for modern office buildings.



### Space Heating

Our comprehensive range of heating solutions provide precise and consistent comfort year-round while helping homes reduce their energy bills.



### Sanitary Heating

Copeland scroll compressors set industry standards for high reliability and outstanding performance for water heating, making them the preferred choice for hotels, restaurants, and hospitals.



### Residential Air Conditioning

Our residential compressors include the latest advances in technology featuring major design improvements and breakthroughs in protection, reliability, efficiency, and sound.



### Commercial Refrigeration

From reducing food wastage in supermarkets, to boosting operational efficiency for cold storage facilities, Copeland technology enables refrigeration solutions to help extend the shelf life of perishables at every step of the lifecycle.



# Table of Contents

Content	Page
Centers for World-Class Manufacturing Excellence	4
Condensing Unit Overview	6
<ul style="list-style-type: none"> <li>ZX Family Condensing Units</li> </ul>	10
<ul style="list-style-type: none"> <li>KHZ Condensing Units</li> </ul>	16
<ul style="list-style-type: none"> <li>F-Series Scroll Condensing Unit</li> </ul>	20
<ul style="list-style-type: none"> <li>Semi-Hermetic Condensing Units</li> </ul>	22
<ul style="list-style-type: none"> <li>Multi-Compressor Racks</li> </ul>	24
<ul style="list-style-type: none"> <li>Water-Cooled Condensing Units</li> </ul>	28
Compressor Overview	32
<ul style="list-style-type: none"> <li>Scroll Compressors</li> </ul>	36
<ul style="list-style-type: none"> <li>Semi-Hermetic Reciprocating Compressors</li> </ul>	42
<ul style="list-style-type: none"> <li>Hermetic Integral Horsepower Reciprocating Compressors</li> </ul>	46
<ul style="list-style-type: none"> <li>Hermetic Fractional Horsepower Reciprocating Compressors</li> </ul>	50

Scan to access:



Copeland Documentation



Asia Product Selection Software



Middle East Africa Product Selection Software

# Centers for World-Class Manufacturing Excellence

## Dubai, United Arab Emirates (UAE)

Technology hub and gateway to Middle East and Africa.



## Dammam, Saudi Arabia

State-of-the-art manufacturing facility serving the region's ever-growing market.



## Karad Engineering Lab, India

The center showcases psychrometric and integrated variable speed laboratories for R32 and R290 refrigerants. Full range testing compressor systems include reliability, performance, energy efficiency and sound level tests.



## Suzhou Research & Solutions Center, China

Founded in 2002, the center is instrumental in the development of new compressors and innovative HVACR solutions for the Asia Pacific region. Equipped with state-of-the-art simulation laboratories, the R&D center boasts of the largest reliability testing lab in Asia.



## Busan Climate Integrated Solutions Lab, Korea

The advanced facility provides a secure testing ground for customers aiming to maximize system performance and optimize energy efficiency.



## Rayong, Thailand

Established In 1997, the Rayong facility is the first high-volume scroll compressor manufacturing plant in Asia.



# Broad Condensing Unit Portfolio

Emerson extends its commitment to developing best-in-class refrigeration solutions for customers with a full line-up of condensing units:



## ZX Family Condensing Unit

Premium line with intelligent controller; high efficiency; compact sizing; low sound. Available with digital or variable speed compressors



## Large ZX Condensing Unit

Extending capacity range of premium ZX condensing unit to meet the challenges of large-scale refrigeration applications



## KHZ Condensing Unit

High-quality & reliable scroll condensing unit. Available with ZB (MT) and ZSI (Extended MT) compressors



## Semi-Hermetic Condensing Unit

Premium CDU using Copeland Discus technology for enhanced performance. Advanced Copeland diagnostic electronics increases reliability



## Multi-Compressor Rack

Best-in-class with robust design, efficiency oil management and integrated electronics for most advanced protection and diagnostics



## F-Series Condensing Unit

Quality indoor scroll condensing unit available with high ambient optimization (Gulf region) and mid ambient optimization (milder climate)



## Indoor Vapor Injection Scroll Condensing Unit

Designed for low temperature applications with scroll vapor injection high efficiency with a full suite of system components for improved reliability



## Water-Cooled Condensing Unit

Reliable and easy to clean and maintain. Designed to deliver exceptional efficiency when used with chilled waterline

# Copeland Condensing Unit Line

● Medium temp   
 ● Low temp   
 ● Ultra Low temp   
 Scroll   
 Reciprocating

## Air-cooled Scroll

	<span style="color: green;">●</span>	ZX		2	2.5	3	4	5	6	7.5										
	<span style="color: blue;">●</span>	ZXL		2	2.5	3	3.5	4	5	6	7.5									
	<span style="color: green;">●</span>	ZXD				3	4	5	6	7.5	9	12	16	20						
	<span style="color: blue;">●</span>	ZXLD									9	12	16	20						
	<span style="color: green;">●</span>	ZXV					4	5		9										
	<span style="color: blue;">●</span>	ZXLV				3	4	5												
	<span style="color: green;">●</span>	KHZ			2	3	4	5	6											
	<span style="color: blue;">●</span>	KHZ LT			2	2.5	3	3.5	4	5	6	7.5								
	<span style="color: blue;">●</span>	KHZ LVL								6	7.5	10	13	15						
	<span style="color: green;">●</span>	F-Line		1	1.5	2	2.5	3	3.5	4	5	6	6.5	7.5	9	10	13			
	<span style="color: blue;">●</span>					2	3	3.5	4	5	6	7.5	10	13						

Note: Rated compressor HP

## Air-cooled Reciprocating

	<span style="color: green;">●</span>	S/H Discus CDU								5	7.5	10	15	22	25	30	33	35	40	
	<span style="color: blue;">●</span>	S/H Two Stage											15	20	25	30			40	
	<span style="color: green;">●</span>	Rack																	66	250
	<span style="color: blue;">●</span>																			45
	<span style="color: green;">●</span>	F-Line		1	1.5	2	3	3.5	4	5										
	<span style="color: blue;">●</span>			1	1.5	2	2.5													

Note: Rated compressor HP

## Water-Cooled

	<span style="color: green;">●</span>	Co-Axial		1	1.3	1.5	1.7	2	2.5	3.5	4	5	6	6.5	7.5					
	<span style="color: blue;">●</span>			1	1.3	1.5	1.7	2	2.5	3.5	4	5	6	6.5	7.5					
	<span style="color: green;">●</span>	Shell Tube						2	2.5	3.5	4	5	6	6.5	8	9	10	13	15	
	<span style="color: green;">●</span>	Shell Tube		0.7	1	1.5	2				4	5								
	<span style="color: blue;">●</span>			0.7	1	1.5	2													

Note: Rated compressor HP

# Condensing Units for Every Application

Emerson offers a comprehensive selection of refrigeration solutions that answers our customers' most demanding requirements.

### Outdoor



**ZX CDU**  
Available with digital and variable speed

● ● ●



**KHZ (ZB)**

● ●



**KHZ (ZSI)**

● ●

### Indoor



**S/H CDU**  
Available with two-stage compressor

● ● ●



**Rack**

● ● ●



**F-Series**

● ● ● ●



**KHZ\*LVL**

● ● ●



**Water Cooled Units**

● ● ● ●

● Medium Temp   
 ● Low Temp   
 Scroll   
 Reciprocating

## Bill of Material Comparison

Medium Temperature	ZX	KHZ	F-Line	S/H CDU
Compressor	ZX	ZB	ZB	Standard/Stream/Discus
Injection Technology	Suction Line Liquid Injection			
Controller	✓			
Intelligent Store Capable	✓			
Fan Speed Controller	✓			
Condenser Type	Fin & Tube/ Microchannel	Fin & Tube	Fin & Tube	Fin & Tube
Chassis	✓	✓	Indoor	Indoor
Filter Drier	✓	✓	Optional	Optional
Sight glass	✓	✓	Optional	Optional
Liquid Receiver	✓		✓	✓
Service Valves	✓	✓	✓	✓
Oil Separator	✓			Optional
HP Switch	✓	✓	✓	✓
LP Switch	✓	✓	✓	✓
Crankcase Heater	✓		✓	Optional
Overload Relays	✓			
Circuit Breaker	✓	✓		Optional
Contactors	✓	✓	✓	✓
Terminal Strip	✓	✓	✓	✓

Low Temperature	ZXL	KHZ	F-Line	S/H CDU	KHZ*LVL
Compressor	ZXI	ZSI	ZF	Standard/Stream/Discus	ZFI
Injection Technology	Vapor				Vapor
Controller	✓				✓
Intelligent Store Capable	✓				
Fan Speed Controller	✓				
Condenser Type	Fin & Tube/ Microchannel	Fin & Tube	Fin & Tube	Fin & Tube	Fin & Tube
Chassis	✓	✓	Indoor	Indoor	Indoor
Filter Drier	✓	✓	Optional	Optional	✓
Sight glass	✓	✓	Optional	Optional	✓
Liquid Receiver	✓	✓	✓	✓	✓
Service Valves	✓	✓	✓	✓	✓
Accumulator	✓	✓		Optional	✓
Oil Separator	✓			Optional	✓
HP Switch	✓	✓	✓	✓	✓
LP Switch	✓	✓	✓	✓	✓
Crankcase Heater	✓		✓	Optional	✓
Overload Relays	✓				
Circuit Breaker	✓	✓			
Contactors	✓	✓	✓	✓	✓
Terminal Strip	✓	✓	✓	✓	✓

Note: The tables show standard bill of material configuration. For the complete list of BOMs please refer to each product's specific catalogue.

# ZX Family Condensing Units



## Best-in-class condensing unit

The ZX condensing unit line-up combines Copeland's exceptional compression technology with smart protection & diagnostics to meet the toughest refrigeration requirements. RS485 port allows for ease of connectivity with the Dixell XWeb platform.

## Market leading efficiency and performance

Achieving high efficiency and performance by combining:

- Copeland scroll compressor
- Fan speed controller
- Optimized condenser coils
- Advanced control algorithms

Digital modulation and vapour injection options deliver great efficiency enhancements.

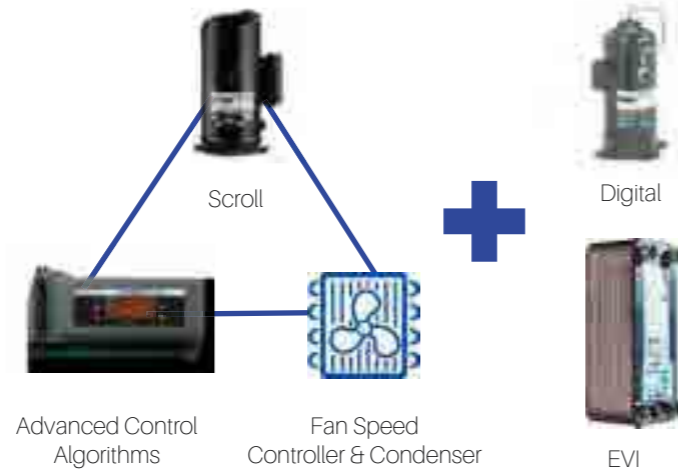

## Diagnostic & Protection

Software designed to improve system performance, save energy and reduce maintenance costs



## Slim and lightweight design

Increases flexibility for installations in limited floor area

## Quiet Operations

Sound jacket significantly reduces noise and vibration



## Connectivity

Used in combination with Dixell XWeb for optimizing operations with real-time monitoring

## Fin and Tube Condenser Models

(Available with R22, R404A, R448A, R449A, R507, R407F)	Capacity (kW)	Motor	PFJ	TFD	PFV	TF5	TF7
		50 Hz	1Ø-220/240v	3Ø-380/420v			
		60 Hz			1Ø-208/230v	3Ø-200/230v	3Ø-380v
		HP					
ZX Medium Temp							
ZX020	3.9	2 HP	x	x	x	x	x
ZX025	4.4	2.5 HP	x				
ZX030	5.4	3 HP	x	x	x	x	x
ZX040	7.1	4 HP	x	x	x	x	x
ZX050	9.8	5 HP		x	x	x	x
ZX060	10.8	6 HP		x		x	x
ZX075	11.8	7.5 HP		x		x	x
ZX076	12.1	7.6 HP		x			
ZX Low Temp							
ZXL020	1.8	2 HP	x	x	x	x	x
ZXL025	2.3	2.5 HP	x	x		x	x
ZXL030	2.5	3 HP	x	x	x	x	x
ZXL035	3.2	3.5 HP		x	x	x	x
ZXL040	3.8	4 HP		x	x	x	x
ZXL050	4.3	5 HP		x	x	x	x
ZXL060	5.3	6 HP		x		x	x
ZXL075	5.9	7.5 HP		x		x	x

Capacity conditions:

Medium Temp: Ambient Temperature 32°C, Evaporating Temp -10°C, Suction Gas 20°C; 50Hz; R404A

Low Temp: Ambient Temperature 32°C, Evaporating Temp -35°C; Suction Gas 20°C; 50Hz; R404A

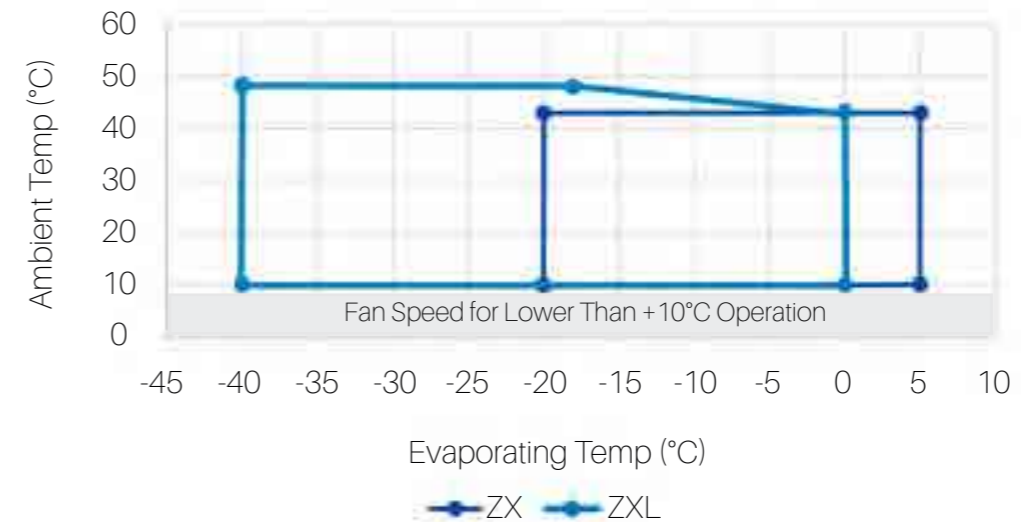

Scan to download documentation:



# ZX Digital Condensing Units



ZXD 12 - 20 HP

## Leveled up performance

Designed and developed to meet the challenges of large scale refrigeration applications

## Fixed speed

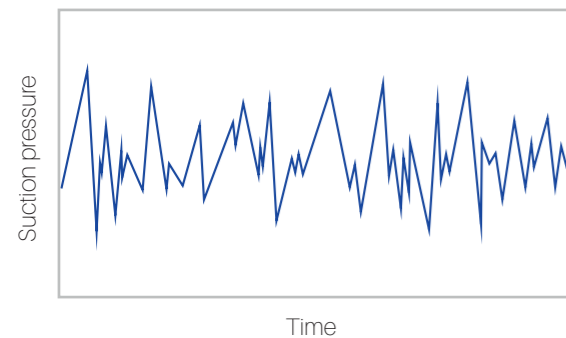

## Digital modulation

Smooth operation across loads

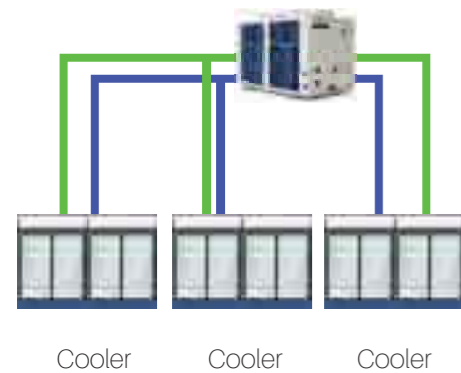
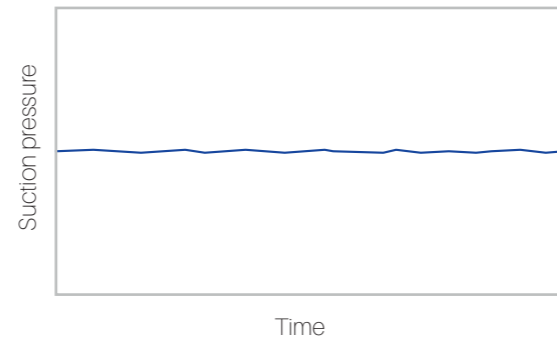

## Multi-evaporator flexibility for retail stores

- Supports multiple showcases
- Digital modulation perfectly matches cooling capacity to fit the refrigeration load requirement, optimizing energy savings

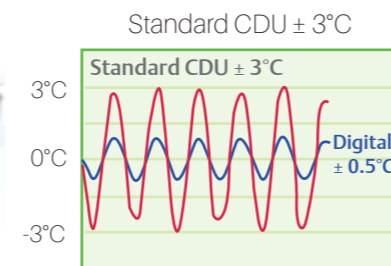

## Temperature control for cold rooms with multiple evaporators

- Precise temperature & relative humidity control
- Reduces dehydration of stored food products
- Less product weight loss & longer shelf life

Model (Available with R22, R404A, R448A, R449A refrigerants)	Capacity (kW)	Motor Code	TFD	TF5	TF7
		50 Hz	3Ø-380/420v		
		60 Hz		3Ø-200/230v	3Ø-380v
		HP			
<b>ZX Digital Medium Temperature</b>					
ZXD030	5.2	3 HP	x		x
ZXD040	7.9	4 HP	x	x	x
ZXD050	9.8	5 HP	x	x	x
ZXD060	10.7	6 HP	x	x	x
ZXD075	11.8	7.5 HP	x	x	x
ZXD076	12.1	8 HP	x		
ZXD090	14.5	9 HP	x		
ZXD120	22.1	12 HP	x		
ZXD160	27.5	16 HP	x		
ZXD200	34.5	20 HP	x		
<b>ZX Digital Low Temperature</b>					
ZXLD090	6.6	9 HP	x		
ZXLD120	10.3	12 HP	x		
ZXLD160	13.8	16 HP	x		
ZXLD200	15.9	20 HP	x		

Capacity conditions:  
 Medium Temp: Ambient Temperature 32°C, Evaporating Temp -10°C; Suction Gas 20°C; 50Hz; R404A  
 Low Temp: Ambient Temperature 32°C, Evaporating Temp -35°C; Suction Gas 20°C; 50Hz; R404A

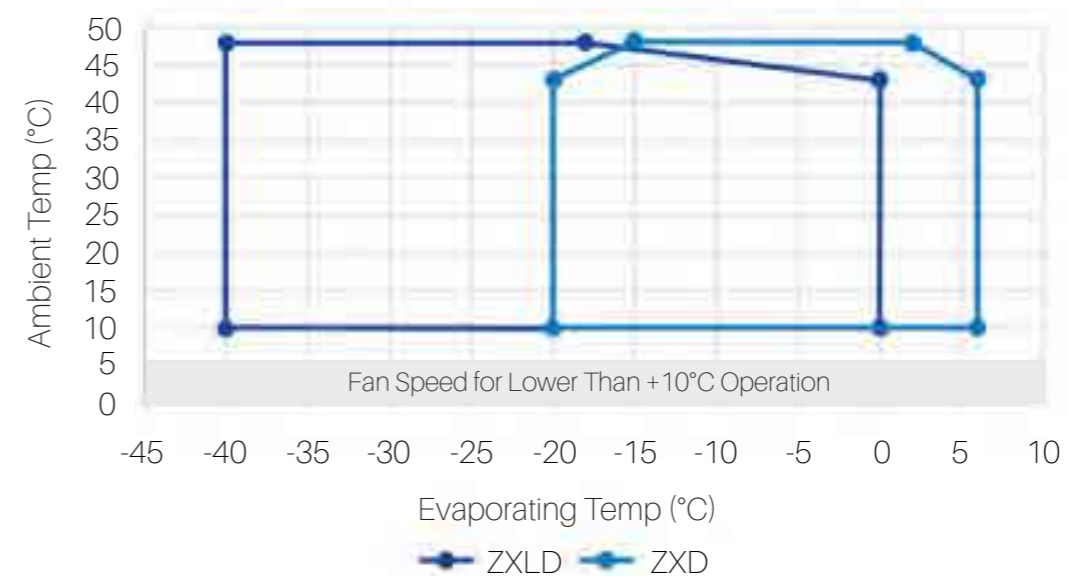

Scan to download documentation:



# ZX Condensing Units with Microchannel Condenser



**ZX with Microchannel Condenser**  
Best-in-class condensing units now with microchannel condenser option

(Available with R404A, R448A, R449A)	Capacity (kW)*	Motor	TFD
		50 Hz	3Ø-380/420v
		60 Hz	
		HP	
<b>Medium Temperature</b>			
ZX020CE	3.9	2 HP	x
ZX030CE	5.5	3 HP	x
ZX040CE	7.3	4 HP	x
ZX050CE	9.1	5 HP	x
ZX060CE	10.9	6 HP	x
ZX075CE	12.1	7.5 HP	x
ZXD030CE	5.3	3 HP	x
ZXD040CE	7.3	4 HP	x
ZXD050CE	9.1	5 HP	x
ZXD060CE	10.9	6 HP	x
ZXD076CE	12.1	7.5 HP	x
ZXD090CE	15.2	9 HP	x
<b>Low Temperature</b>			
ZXL020CE	1.8	2 HP	x
ZXL025CE	2.3	2.5 HP	x
ZXL030CE	2.6	3 HP	x
ZXL035CE	3.2	3.5 HP	x
ZXL040CE	3.8	4 HP	x
ZXL050CE	4.5	5 HP	x
ZXL060CE	5.5	6 HP	x
ZXL075CE	5.9	7.5 HP	x
ZXLD090CE	6.7	9 HP	x

\*Preliminary Data  
Capacity conditions:  
MT: Ambient Temperature 32°C, Evaporating Temp -10°C, Suction Gas 18.3°C; 50Hz; R404A  
LT: Ambient Temperature 32°C, Evaporating Temp -35°C, Suction Gas 18.3°C; 50Hz; R404A

# ZX Variable Speed Condensing Units



**ZX Variable Speed**  
Delivering all year-round efficiency improvement through precise modulation to match required cooling load.

- Delivers extra capacity when required such as during pull downs
- Modulates capacity to fit the requirement during non peak operating hours

(Available with R404A, R448A, R449A)	Minimum Capacity (kW)	Nominal Capacity (kW)	Maximum Capacity (kW)	Motor	4XD	4XK	5XJ
				50 Hz	3Ø-380/420v		
				60 Hz		3Ø-380/420v	3Ø-200/240v
<b>Medium Temperature</b>							
ZXV065	2.58	6.20	7.87		x	x	x
ZXV085	3.27	7.85	9.97		x	x	x
ZXV130	4.05	10.08	14.38		x	x	x
<b>Low Temperature</b>							
ZXLV030	0.92	2.30	3.01		x	x	x
ZXLV040	1.16	2.91	3.81		x	x	x
ZXLV050	1.41	3.81	5.12		x	x	x

Capacity Conditions:  
MT: Ambient Temperature 32°C, Evaporating Temp -10°C, Gas Return 5 °C; 50Hz; R404A  
LT: Ambient Temperature 32°C, Evaporating Temp -35°C, Gas Return 5°C; 50Hz; R404A

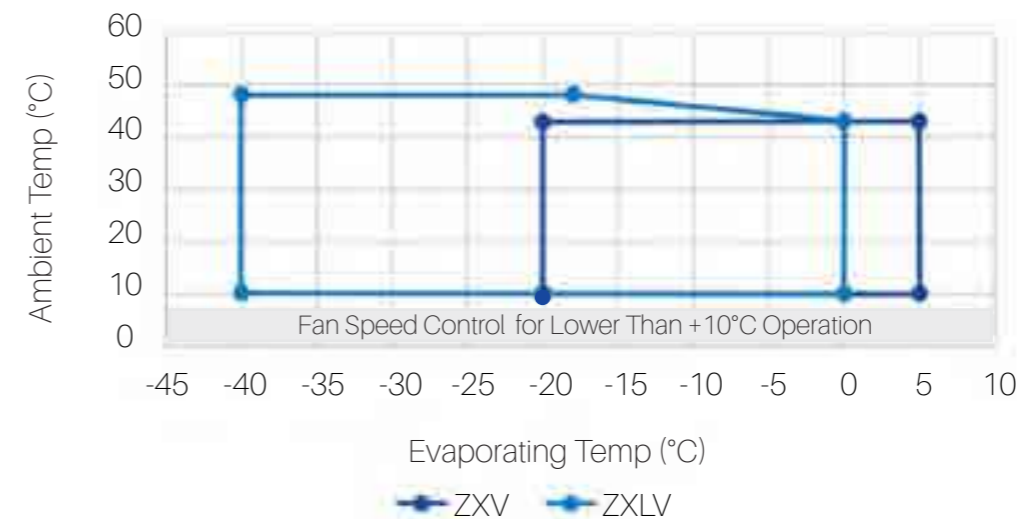

Scan to download documentation:





# KHZ Condensing Units



## Quality condensing units

K family condensing units are available in 2 compressor options housed in a slim, durable chassis:

- KHZ (ZB Scroll): Medium temperature unit optimized for reliability and efficiency for tropical climates
- KHZ LT (ZSI Scroll): Designed for flexibility with evaporating temperature range between -35°C and 0°C



## High-quality chassis

Powder coated chassis for additional weather protection with accessible panel door for ease of maintenance and servicing



ZB

ZSI

## Flexible choice of technology

Flexibility of compressors offer versatility for various applications



## Ready for installation

Factory installed electrical box with contactor, terminal strip and circuit breaker simplifies on-site installation



## Customized protection

Standard: filter dryer, sight glass  
Customizable: oil separator, crankcase heater, overload relay

Model (Available with R22, R404A)	Compressor	Capacity (kW)	Motor	PFJ	TFD
			50 Hz	1Ø-220/240v	3Ø-380/420v
			HP		
<b>KHZ Medium Temp (Scroll)</b>					
KHZ515	ZB15K	3.8	2 HP	X	X
KHZ521	ZB21K	5.1	3 HP	X	X
KHZ529	ZB29K	6.9	4 HP		X
KHZ538	ZB38K	8.7	5 HP		X
KHZ546	ZB46K	10.4	6 HP		X
<b>KHZ Low Temp (Scroll)</b>					
KHZ506LRL	ZSI06K	1.7	2 HP	X	X
KHZ508LRL	ZSI08K	2.0	2.5 HP	X	X
KHZ509LRL	ZSI09K	1.8	3 HP		X
KHZ511LRL	ZSI11K	2.1	3.5 HP		X
KHZ514LRL	ZSI14K	3.1	4 HP		X
KHZ515LRL	ZSI15K	3.5	5 HP		X
KHZ518LRL	ZSI18K	4.7	6HP		X
KHZ521LRL	ZSI21K	5.4	7.5 HP		X

Capacity Conditions:

MT: Ambient Temperature 32°C, Evaporating Temp -10°C; Gas Return 18.3°C; 50Hz; R404A

LT: Ambient Temperature 32°C, Evaporating Temp -25°C; Gas Return 18.3°C; 50Hz; R404A

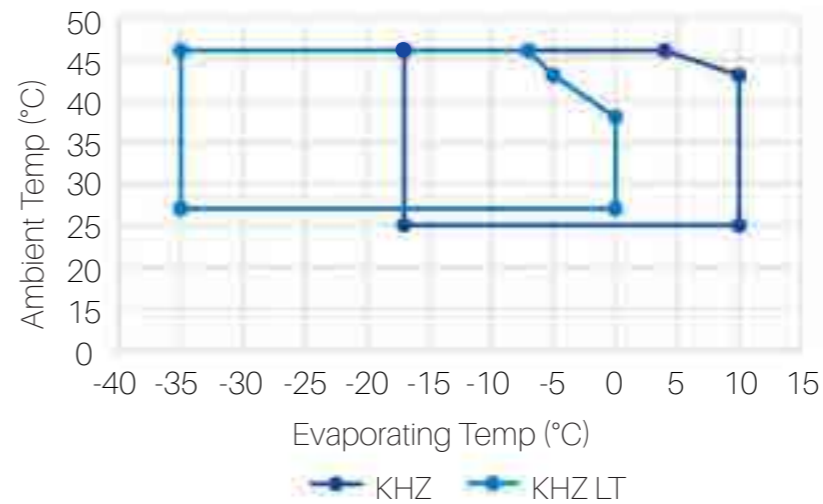

Scan to download documentation:



KHZ MT

KHZ LT

# Indoor Vapor Injection Condensing Unit (KHZ\*LVL)



## Highly efficient indoor condensing unit

Designed for low temperatures, using vapor injection technology to deliver higher capacity and efficiency. A full suite of system components delivers unmatched reliability.

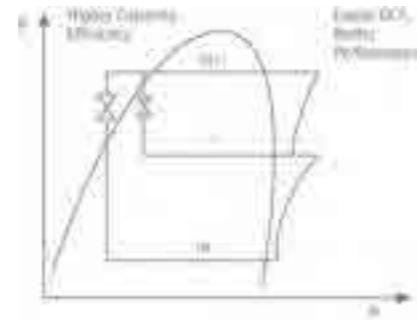

## Vapor Injection

Improved system capacity and efficiency

Model	HP	Capacity (kW)
KHZ526LVL	6HP	5.9
KHZ536LVL	7.5HP	7.6
KHZ550LVL	10HP	10.2
KHZ559LVL	13HP	12.3
KHZ568LVL	15HP	13.7

Ambient Temp 32°C, Evaporating Temp -35°C, Suction Gas 18°C, 50Hz, R404A  
Available TFD Configuration (30-380/420v) R404A

Scan to download documentation:



## Dual Compliance Scroll

Strong liquid and debris handling. Reduced performance degradation over time

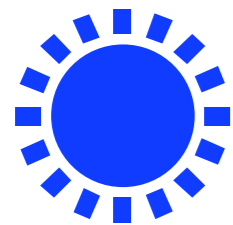

## Optimized For High Ambient Temperatures

Condenser and fan optimized for reliability and efficiency, dependable ambient temperature performance of up to 46°C

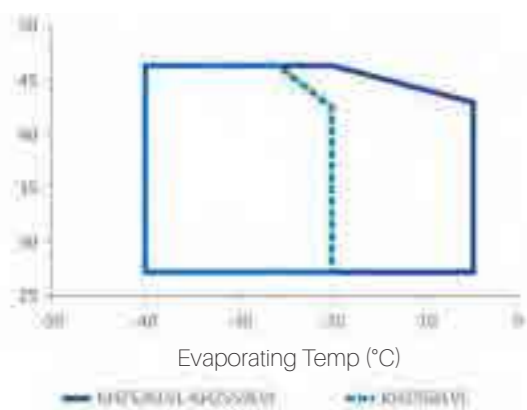

# F-Series Scroll Condensing Units



## Simple & compact condensing units

Compact design with silent fans and an efficient Copeland scroll compressor. F-Series units make for an ideal solution for limited installation areas.

Available in two options:

- **High-ambient** (Gulf cooperation countries): maximum ambient of 46°C
- **Mid-ambient** (Egypt, Jordan, Lebanon): maximum ambient of 43°C



## Copeland scroll

Reliable and highly efficiency compressors for refrigeration applications



## Ready for installation

Factory installed electrical box with contactor, terminal strip and circuit breaker simplifies on-site installation

## Medium temperature envelope

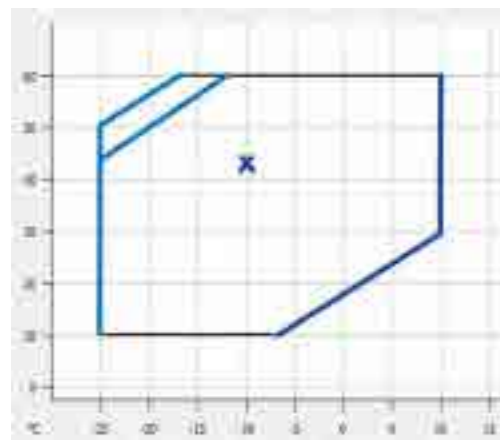

-10°C Evap, 43°C Ambient,  
0°C Sub-Cooling, 20°C Return Gas

## Low temperature envelope

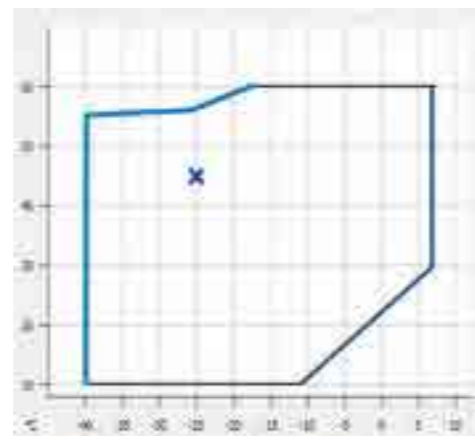

-25°C Evap, 43°C Ambient,  
0°C Sub-Cooling, 20°C Return Gas

Model (Available with R134a and R404A)	Capacity (kw)	Motor	PFZ		TFM		TF5/TF7	CFV
		50 Hz	1Ø-220/240v		3Ø-380/420v		3Ø-230v	
		60 Hz					3Ø-380v	1Ø 220/230v
HP	High Ambient	Mild Ambient	High Ambient	Mild Ambient	High Ambient	High Ambient		
Medium Temperature								
FMC8A-ZS09	2.2	1 HP	x	x	x	x	x	
FMC8A-ZS11	2.6	1.5 HP	x	x	x	x	x	
FMD8A-ZB15	3.3	2 HP			x	x	x	
FMH7A-ZB19	4.2	2.5 HP			x	x	x	
FMH8A-ZB21	5.1	3 HP			x	x	x	
FMH8A-ZB26	5.7	3.5 HP			x	x	x	
FMM8A-ZB29	6.8	4 HP			x	x	x	
FMR6A-ZB38	8.6	5 HP			x	x	x	
FMR7A-ZB45	10.2	6 HP			x	x	x	
FMR7A-ZB48	10.9	6.5 HP			x	x	x	
FMS9A-ZB58	13.2	8 HP			x	x	x	
FMV9A-ZB66	15.1	9 HP			x	x	x	
FMV6A-ZB76	18.5	10 HP			x	x		
FMV6A-ZB95	21.7	13 HP			x	x		
Low Temperature								
FLD8A-ZF06	1.4	2 HP			x	x		x
FLD8A-ZF09	1.9	3 HP			x	x		x
FLH7A-ZF11	2.4	3.5 HP			x	x		x
FLH8A-ZF13	2.8	4 HP			x	x	x	
FLM8A-ZF15	3.4	5 HP			x	x	x	
FLR6A-ZF18	4.2	6 HP			x	x	x	
FLR7A-ZF25	5.2	7.5 HP			x	x		
FLV9A-ZF34	6.9	10 HP			x	x		
FLV6A-ZF41	8.8	13 HP				x		

Capacity Conditions:  
MT: Ambient Temperature 32°C, Evaporating Temp -10°C, Gas Return 18.3°C; 50Hz; R404A  
LT: Ambient Temperature 32°C, Evaporating Temp -35°C, Gas Return 18.3°C; 50Hz; R404A

Scan to download documentation:



50Hz

60Hz

# Semi-Hermetic Condensing Units



## Premium performance, robust durability

The industry standard for efficiency and reliability, Copeland semi-hermetic condensing units are renowned for its versatility and durability for multiple refrigeration applications

Available in two versions:

1. Copeland Discus condensing units
2. Copeland two-stage condensing units



## Highly-efficient Copeland Discus

Discus valve allows more efficient compressor stroke and performance



## Copeland Compressor Electronics

Unlocks advanced diagnostics, protection and communication capabilities



## Available with two-stage option

Enables ultra-low evaporating temperatures of up to -60°C



## Flexible BOM option

- F01: Sight Glass and Filter Dryer
- F02: F01 + Oil Separator
- F03: F02 + Suction Accumulator

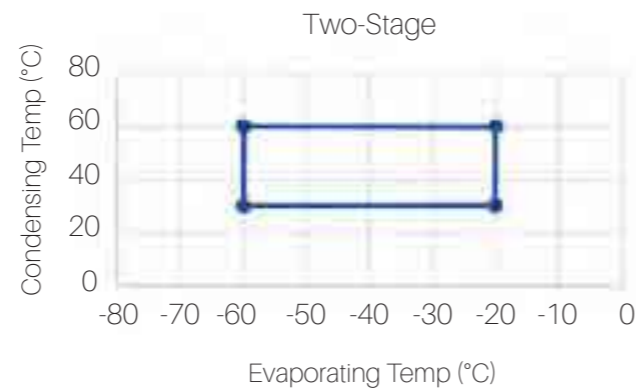
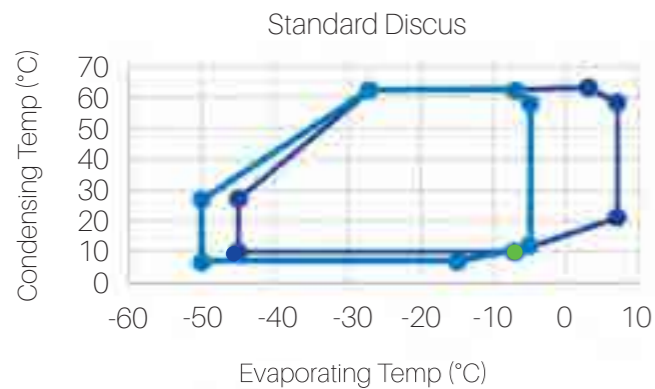

Model (Available with R22, R404A, R407C and R134a)	Capacity (kW) Medium Temp	Capacity (kW) Low Temp	Motor	AWM	EWK
			50 Hz	3Ø-380/420v	
			60 Hz		3Ø-230v 3Ø-380v
			Motor HP		

Medium Temp Optimized					
R7-2DD-50X	9.9	3.1	5 HP	x	x
S9-2DL-75X	11.8	3.8	7.5 HP	x	x
S9-2DB-75X	14.2	5.1	7.5 HP	x	x
S9-3DA-75X	16.0	5.4	7.5 HP	x	x
V6-3DC-100X	24.5	9.3	10 HP	x	x
W9-3DS-150X	26.2	9.4	15 HP	x	x
Z9-4MA-22X	34.8	11.7	22 HP	x	x
Z9-4MH-25X	39.6	13.4	25 HP	x	x
Z9-4MI-30X	43.1	15.4	30 HP	x	x
Z9-4MJ-33X	46.9	17.0	33 HP	x	x
Z12-4MK-35X	55.6	19.6	35 HP	x	x
Z12-6MI-40X	64.6	23.1	40 HP	x	x

Low Temp Optimized					
R7-2DB-50X	15.2	4.8	5 HP	x	x
R7-3DC-75X	16.2	6.7	7.5 HP	x	x
S9-3DS-100X	21.5	9.0	10 HP	x	x
W9-4MF-13X	28.8	10.8	13 HP	x	x
W9-4ML-15X	33.1	13.1	15 HP	x	x
W9-4MM-20X	34.6	14.5	20 HP	x	x
W9-4MT-22X	37.6	15.9	22 HP	x	x
Z9-4MT-22X	46.9	17.7	22 HP	x	x
Z9-4MU-25X	50.7	19.5	25 HP	x	x
Z9-6MM-30X	58.1	22.8	30 HP	x	x
Z12-6MU-40X	76.7	29.1	40 HP	x	x

Blast Freezing Two-Stage					
Z9-6TA-150X SUB		14.7	15 HP	x	x
Z9-6TH-200X SUB		18.4	20 HP	x	x
Z12-6TJ-250X SUB		20.8	25 HP	x	x
Z12-6TJW-250E SUB		21.9	25 HP	x	x
Z12-6TKW-300E-SUB		27.1	30 HP	x	x

Capacity Conditions:  
 Medium Temp: Ambient Temperature 32°C, Evaporating Temp -10°C; Suction Gas 20°C; 50Hz; R404A  
 Low Temp: Ambient Temperature 32°C, Evaporating Temp -35°C; Suction Gas 20°C; 50Hz; R404A  
 Blast Freezing: Ambient Temperature 32°C, Evaporating Temp -45°C; Suction Gas 20°C; 50Hz; R404A

Scan to download documentation:



50Hz

60Hz

# Copeland Multi-Compressor Rack

For medium and low temperature applications, Multi-Compressor Racks are the ideal choice for supermarkets, hypermarkets and large cold rooms.

- Nominal Capacities (kW) : 96 to 395 (Medium Temp)  
55 to 193 (Low Temp)
- Refrigerants : R134a/R404A (MT) and R404A (LT)
- Electrical : AWM- 50Hz: 380-420V/3ph - Part Wind Start  
EWK - 60Hz: 380-420/3ph - DOL



## Features



### Stream compressor

- High efficiency Discus valve
- Advanced compressor diagnostics
- Robust line control oil reservoir, oil separator & oil filter oil level regulator (with sight glass)
- Effective oil management, removes impurities
- Electronic oil control option
- Active oil management with safety alarm (electronic only)
- Oil pressure switch



### Electrical panel with Dixell™ electronics

- Electronic controller (Dixell iPro rack controller) - with display alarms and i/o relays for safety and communication.
- Flexible and easy to configure
- Circuit breakers and thermal overload protection (for individual compressors and for condenser fan - max 4 stages)
- Optimized algorithms for efficient rack compressor control



### Dual pressure switches

- Adjustable pressures and differentials



### Suction header with suction filters (with replaceable core)

- Smooth & optimized distribution of refrigerant
- Adequately sized & insulated
- Suction stubs with easily accessible ball valves for isolation



### Common discharge header

- Adequately sized to avoid oil traps
- Heavy gauged discharge piping, Protected within rack frame



### Mounting frame

- Spring-mounted robust MS frame to reduce noise & vibration
- Easy serviceability

## Nomenclature

EMPB	-	4	4M	080	L	K	-	XXX
Emerson multi-compressor pack		Number of compressors in parallel	Compressor family 4M   STREAM (4/6 Cylinder) 6M	Nominal rack system capacity in HP	Application L: Low temp M: Medium temp	Frequency K:EWK M:AWM		Scope of supply

## Product range

Medium temperature application

Model Name	Compressor	No. of Compressors	HP	Capacity (kW)
EMPB-34M066MM	4MA-22X	3	066	96
EMPB-44M075MM	4MH-25X	3	075	113
EMPB-44M090MM	4MI-30X	3	090	125
EMPB-34M099MM	4MJ-33X	3	099	140
EMPB-34M105MM	4MK-35X	3	105	157
EMPB-36M120MM	6MI-40X	3	120	190
EMPB-36M135MM	6MJ-45X	3	135	212
EMPB-36M150MM	6MK-50X	3	150	237
EMPB-44M088MM	4MA-22X	4	088	128
EMPB-44M100MM	4MH-25X	4	100	150
EMPB-44M120MM	4MI-30X	4	120	167
EMPB-44M132MM	4MJ-33X	4	132	186
EMPB-44M140MM	4MK-35X	4	140	209
EMPB-46M160MM	6MI-40X	4	160	253
EMPB-46M180MM	6MJ-45X	4	180	282
EMPB-46M200MM	6MK-50X	4	200	316
EMPB-56M225MM	6MJ-45X	5	225	353
EMPB-56M250MM	6MK-50X	5	250	395

Low temperature application

Model Name	Compressor	No. of Compressors	HP	Capacity (kW)
EMPB-34M045LM	4ML-15X	3	045	55
EMPB-34M060LM	4MM-20X	3	060	61
EMPB-34M066LM	4MT-22X	3	066	69
EMPB-34M075LM	4MU-25X	3	075	76
EMPB-36M090LM	6MM-30X	3	090	92
EMPB-36M105LM	6MT-35X	3	105	104
EMPB-36M120LM	6MU-40X	3	120	116
EMPB-44M060LM	4ML-15X	4	060	73
EMPB-44M080LM	4MM-20X	4	080	82
EMPB-44M088LM	4MT-22X	4	088	92
EMPB-44M100LM	4MU-25X	4	100	101
EMPB-46M120LM	6MM-30X	4	120	122
EMPB-46M140LM	6MT-35X	4	140	138
EMPB-46M160LM	6MU-40X	4	160	154
EMPB-56M175LM	6MT-35X	5	175	173
EMPB-56M200LM	6MU-40X	5	200	193

Capacity Conditions: Calculated for R404A at  
 MT: Evaporating Temp: -10°C / Condensing Temp: 45°C / Superheat: 20K  
 LT: Evaporating Temp: -25°C / Condensing Temp: 45°C / Superheat: 20K  
 For detailed rack performance at various operating conditions, please contact your local Emerson sales representative

Scan to download documentation:



50Hz

60Hz

# Semi-Hermetic K/L Condensing Unit



Model (Available with R22, R134a, R404A)	Capacity (kW) Medium Temp	Capacity (kW) Low Temp	Motor	EWL	EWK
			50 Hz	3Ø 380-420v	
			60 Hz		
<b>Medium Temp Optimized</b>					
B8-KM-7X	1.89	0.60		x	x
B8-KJ-10X	2.38	0.80		x	x
D8-KSJ-15X	3.24	1.11		x	x
D8-KSL-20X	4.33	1.58		x	
H8-KSL-20X	4.82	1.66		x	
H8-LE-20X	4.83	1.33		x	x
H8-LF-30X	6.30	2.05		x	x
P8-LF-30X	6.90	2.14		x	
H8-LJ-30X	6.75	2.26		x	
P8-LJ-30X	7.48	2.38		x	
H8-LL-40X	8.07	2.75		x	
P8-LL-40X	9.12	2.93		x	
<b>Low Temp Optimized</b>					
B8-KJ-7X		0.83		x	
B8-KSJ-10X		1.05		x	x
B8-KL-15X		1.21		x	x
D8-LF-20X		1.65		x	x
H8-LJ-20X		2.09		x	
H8-LL-30X		2.73		x	x
H8-LSG-40X		3.41		x	

Capacity Conditions:  
 MT: Ambient Temperature 32°C, Evaporating Temp -10°C; Gas Return 5°C; 50Hz; R404A  
 LT: Ambient Temperature 32°C, Evaporating Temp -35°C; Gas Return 5°C; 50Hz; R404A

Scan to download documentation:



50Hz

60Hz

# F-Series Recip Condensing Units



Simple & compact recip units

Compact design with silent fans and cost-effective reciprocating compressor

Available Components: Compressor, Condenser, Receiver, HP/LP Switch and Crankcase Heater

Model	Capacity (kW)	Motor	EWL	EWK
		50 Hz	3Ø-380/420v	1Ø-220/240v
		60 Hz		
		HP		
<b>Medium Temp (R22 Only)</b>				
FMC8A-CJ513	1.9	1 HP		x
FMD8A-CR 22	2.8	1.5 HP		x
FMD8A-CR 30	3.4	2 HP		x
FMH8A-CR 36	4.5	3 HP	x	x
FMM8A-CR 42	5.4	3.5 HP	x	
FMR6A-CR 53	7.1	4.5 HP	x	
FMR7A-CR 62	8.3	5 HP	x	
<b>Low Temp (R404A)</b>				
FLC8A-CM475	1.1	1 HP		x
FLH7A-CM512	1.4	1.25 HP	x	
FLH7A-CM515	1.6	2 HP	x	
FLH8A-CM517	2.0	2.25 HP	x	
FLH8A-CM520	2.1	2.5 HP	x	

Capacity Conditions:  
 MT: Ambient Temperature 32°C, Evaporating Temp -10°C; Gas Return 5°C; 50Hz; R404A  
 LT: Ambient Temperature 32°C, Evaporating Temp -35°C; Gas Return 5°C; 50Hz; R404A

Scan to download documentation:



# Water-Cooled Condensing Units

## Co-Axial Condenser



Compact design,  
increased reliability

Scroll condensing units from 1.3 HP -7.5 HP with high efficiency scroll for hospitality and process applications. Available with R134a and R404A refrigerants



### Co-axial Condenser

Easy cleaning and operates at higher pressure than shell and tube (20 bar vs. 10 bar)



### Copeland Scroll Compressor

Gold standard reliability with high efficiency and low sound



### System Protection Components

Sight glass, Crank case heater, high pressure, Low pressure switch and water valve

Scan to download documentation:



50Hz



60Hz

Model	HP	Capacity <sup>1</sup> (kW) R134A	Capacity <sup>2</sup> (kW) R404A	Motor	TFD
				50 Hz	3Ø-380/420v
				60 Hz	3Ø-380/460v
FPWD-C13Z-TFD	1.3	1.84	1.83		X
FPWD-C15Z-TFD	1.5	2.20	2.19		X
FPWD-C17Z-TFD	1.7	2.50	2.50		X
FPWD-C20Z-TFD	2.0	2.95	2.75		X
FPWD-C25Z-TFD	2.5	3.41	3.49		X
FPWD-C30Z-TFD	3.0	4.29	4.14		X
FPWD-C35Z-TFD	3.5	4.96	4.82		X
FPWD-C40Z-TFD	4.0	5.81	5.66		X
FPWD-C50Z-TFD	5.0	7.23	7.03		X
FPWD-C60Z-TFD	6.0	8.79	8.28		X
FPWD-C65Z-TFD	6.5	9.85	9.55		X
FPWD-C75Z-TFD	7.5	10.89	10.79		X

Capacity Conditions:

(1) -5°C Evaporating Temp; 35°C Condensing Temp; 20°C Suction Return; 3K Subcooling

(2) -20°C Evaporating Temp; 35°C Condensing Temp; 20°C Suction Return; 3K Subcooling

### R404A: Medium Temp/ Low Temp

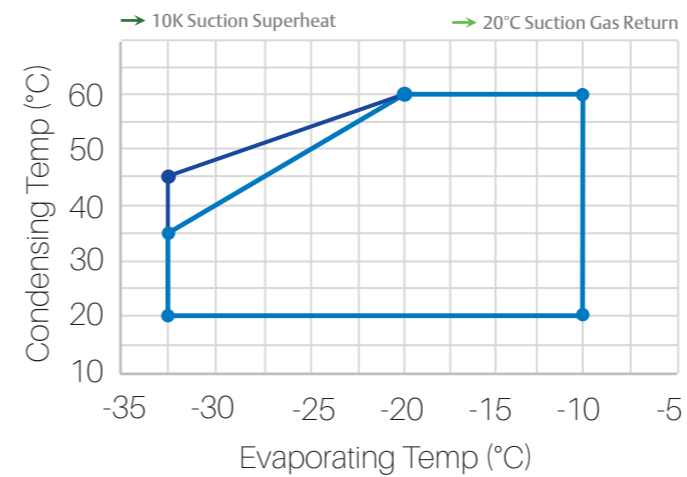

### R134A: High Temp/ Medium Temp

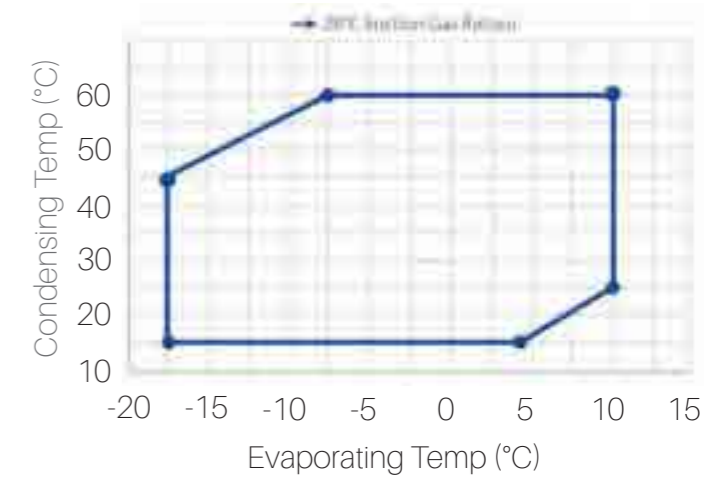

# Water-Cooled Condensing Unit Semi-Hermetic With Shell In Tube Condenser



## Semi-Hermetic Water-Cooled Condensing Unit

Compact, efficient and easy to maintain. Designed to deliver exceptional efficiency when used with chilled water line.

- Medium Temp: WDH R134a, WMH R404a
- Low Temp: WDH R404a

Model (Available with R404A and R448A)	Motor HP	Capacity <sup>1</sup> (kW) Medium Temp	Capacity <sup>2</sup> (kW) Low Temp	Motor	EWL	EWK
				50 Hz	3Ø-380/420v	
				60 Hz		3Ø-380/420v
<b>Medium Temp Version With R134A or Low Temp Version with R404A</b>						
WDH1A-KJ007	0.7	2.39	2.21		x	x
WDH1A-SJ010	1	2.89	2.79		x	x
WDH1A-KL015	1.5	3.35	3.22		x	x
WDH1A-SL020	2	4.26	4.07		x	x
WDH2A-LF020	2	5.82	5.22		x	x
WDH2A-LJ020	2	6.51	6.34		x	x
WDH3A-LL030	3	8.37	8.20		x	x
WDH4A-SG040	4	10.60	10.25		x	x
WDH4A-HA050	5	12.45	12.10		x	x
<b>Medium Temp Version with R404A</b>						
WMH1A-KM007-EWL	0.7	3.07			x	
WMH1A-KJ010-EWL	1	4.18			x	
WMH1A-SJ015-EWL	1.5	5.16			x	
WMH3A-LE020-EWL	2	7.94			x	
WMH4A-LF030-EWL	3	10.85			x	
WMH4A-LJ030-EWL	3	12.10			x	

Capacity Conditions:  
(1) -5°C Evaporating Temp; 30°C Condensing Temp; 20°C Suction Return; 3K Subcooling, 50Hz  
(2) -20°C Evaporating Temp; 30°C Condensing Temp; 20°C Suction Return; 3K Subcooling, 50 Hz

Scan to download documentation:



50Hz

60Hz

# Water-Cooled Condensing Unit Scroll With Shell In Tube Condenser



## Scroll Water-Cooled Condensing Unit

- Designed and built with high quality shell & tube condenser with good tolerance against foul water
- Condenser easy to clean and maintain
- Scroll compressors delivers robust and efficient performance
- High pressure/low pressure switch mounted
- Optional accessories: condenser with liquid level sight glass, filter drier, suction accumulator, oil separator, vibration eliminator



## Shell in Tube Condenser

Simple cleaning and maintenance. Easily remove build up scaling around the condenser



## Highly Efficient ZB Compressor

Gold standard reliability with high efficiency and low sound

Model (Available with R32 and R404A)	Compressor	Capacity (kW)	Motor	TFD
			50 Hz	3Ø-380/420v
			HP	
EWC-ZZB15KQE-AL-106	ZB15KQE-TFD-524	5.2	2 HP	x
EWC-ZZB19KQE-AL-106	ZB19KQE-TFD-524	6.4	2.5 HP	x
EWC-ZZB21KQE-AL-106	ZB21KQE-TFD-524	6.6	3 HP	x
EWC-ZZB26KQE-AL-106	ZB26KQE-TFD-524	7.7	3.5 HP	x
EWC-ZZB29KQE-AL-106	ZB29KQE-TFD-524	10.4	4 HP	x
EWC-ZZB38KQE-AL-106	ZB38KQE-TFD-524	13.1	5 HP	x
EWC-ZZB45KQE-AL-106	ZB45KQE-TFD-524	15.3	6 HP	x
EWC-ZZB48KQE-AL-106	ZB48KQE-TFD-524	16.9	6.5 HP	x
EWC-ZZB58KQE-AL-106	ZB58KQE-TFD-551	20.3	8 HP	x
EWC-ZZB66KQE-AL-106	ZB66KQE-TFD-551	22.7	9 HP	x
EWC-ZZB76KQE-AL-106	ZB76KQE-TFD-551	27.0	10 HP	x
EWC-ZZB95KQE-AL-106	ZB95KQE-TFD-551	33.1	13 HP	x
EWC-ZZB114KQE-AL-106	ZB114KQE-TFD-551	39.7	15 HP	x

Capacity Conditions: Condensing Temperature 30°C, Evaporating Temp 0°C; 50Hz; R404A



# History of Refrigeration Compressors



Mr. Edmund Copeland

Trusted by HVACR professionals worldwide for efficient, reliable performance and breakthrough innovations, the Copeland name is synonymous with compressors. The world's first successful mechanical refrigeration system was developed by Copeland Corporation and is proudly displayed in the Smithsonian museum in Washington D.C., United States.

Steady growth followed Copeland in the following years and went on to expand semi-hermetic technology from 1/2HP to 60HP. Licensing designs to DWM (Germany), Prestcold (UK), COMEF (France) and Gelpha (Spain).

The first refrigeration scroll models were produced in 1993 and enabled users to reimagine the potential application for commercial refrigeration architecture. EVI (Enhanced Vapor Injection) brought a step change in efficiency and digital unloading introduced the world to the first compressor with a modulation range of 10% to 100%.

Today, refrigeration compressors range from 0.5HP to 60HP and cools everything from storing ripe bananas at +14°C to freeze drying durian at -50°C.



First refrigeration scroll	ZB scroll Asia production	Digital scroll	Fusion semi-hermetic scroll	Low temp ZSI scroll
1993	1996	2005	2009	2012



Variable speed	Low temp EVI scroll	Large ZB Refrigeration scroll	Fractional HP with R290	Large low temp EVI scroll
2016	2017	2018	2019	2020

# Copeland Compressor Portfolio

## Medium Temperature

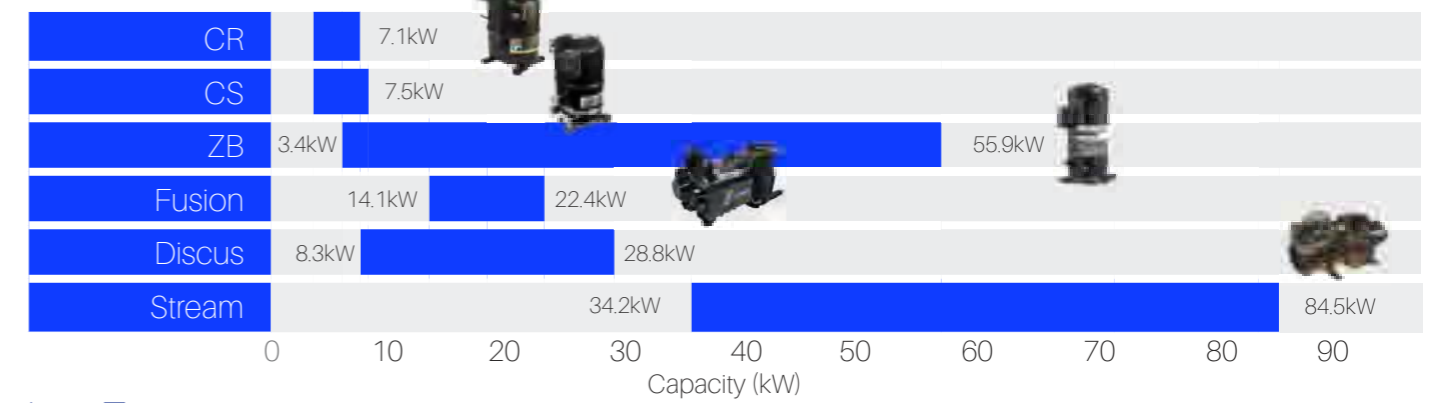

## Low Temperature

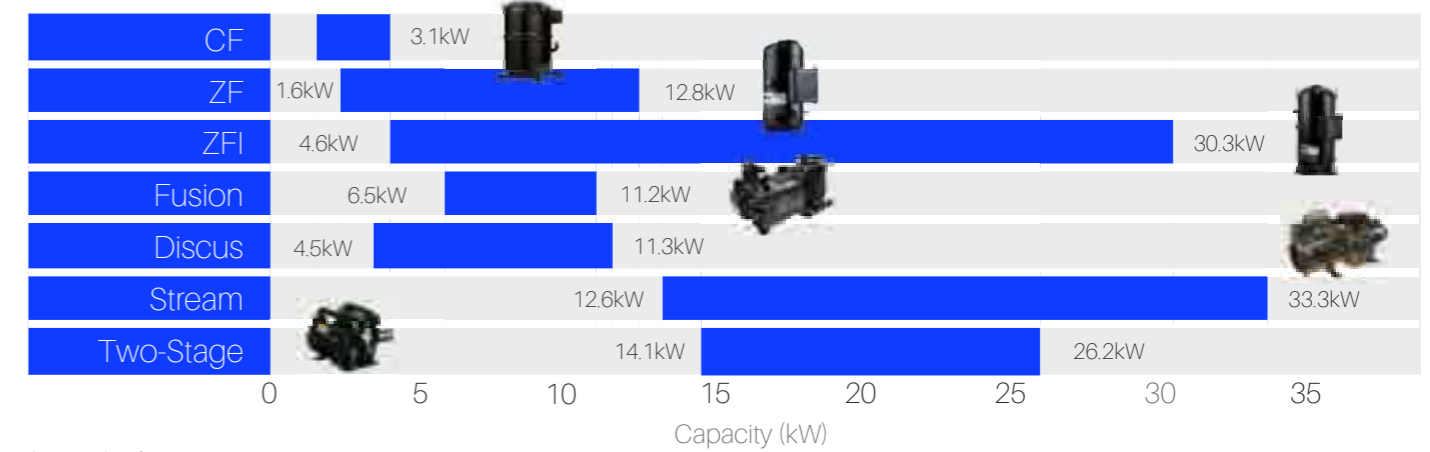

Capacity Conditions:  
 Medium Temp: Evaporating Temp -6.7°C, Condensing Temp 48.9°C Suction Gas 18.3°C, 50Hz, R404A  
 Low Temp: Evaporating Temp -31.7°C, Condensing Temp 40.6°C Suction Gas 18.3°C, 50Hz, R404A

## Fractional Horsepower

### High Temperature

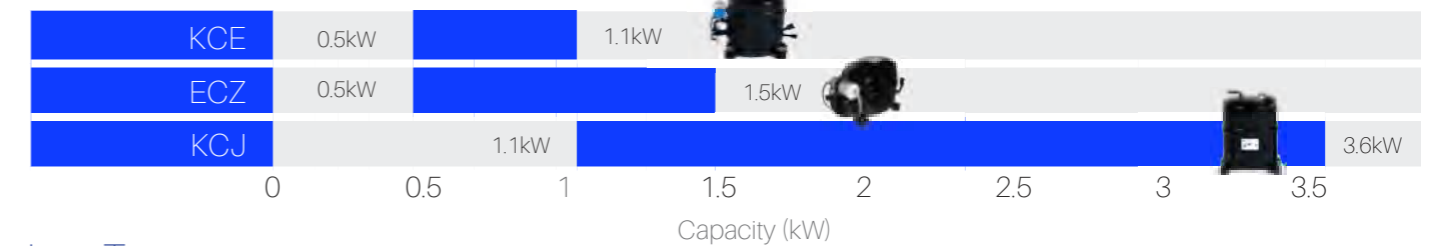

### Low Temperature



Capacity Conditions:  
 High Temp: +7.2°C Evaporating Temp/ 54.4°C Condensing Temp/ 35°C Return Gas/ 8.3K Subcooling R134A, 50Hz  
 Low Temp: -23.3°C Evaporating Temp/ 54.4°C Condensing Temp/ 35°C Return Gas/ 8.3K Subcooling R404A, 50Hz











# Medium Temperature Compressor Line-up

	CR K6	CS K6	CS K7		ZB	Fusion	Copeland Stream
							
<b>Envelope*</b>							
<b>Type</b>	Hermetic reciprocating	Hermetic reciprocating	Hermetic reciprocating		Scroll	Semi-hermetic scroll	Semi-hermetic reciprocating
<b>Range (HP)</b>	1.5 - 5 HP	1 - 3.5 HP	1 - 3.5 HP		2 - 30 HP	11 - 20 HP	22 - 50 HP
<b>Range (kW)</b>	2.5-7.1 kW	2.4-7.5 kW	2.4-7.5 kW		3.4 - 55.9 kW	14.1 - 22.4 kW	34.2 - 84.5 kW
<b>Refrigerant</b>	R22,R407C	R22, R404A, R448A, R449A	R22, R404A, R448A, R449A		R22, R404A, R134a	R22, R404A	R22, R134a, R404A, R407C
<b>Designed for</b>	High temp medium temp	Medium to extended medium temp	Medium to extended medium temp		Medium temp	Medium temp low temp	Medium temp low temp
<b>Description</b>	Efficient HT and MT compressors designed for tropical climates	Highly-efficient and reliable US design for MT and Ext MT (-32°C to +0°C)	Extended envelope version of CSK6 to allow for better pull-down performance		Gold standard reliability and efficiency	Designed for both MT and LT. Fusion compressors delivers efficient and quiet performance	Rugged and reliable with industry-leading efficiency through Discus valve CoreSense for advance diagnostics

Capacity Conditions:  
 Medium Temp: Evaporating Temp -6.7°C; Condensing Temp 48.9°C Suction Gas 18.3°C; 50Hz R404A  
 Low Temp: Evaporating Temp -31.7°C; Condensing Temp 40.6°C Suction Gas 18.3°C; 50Hz; R404A

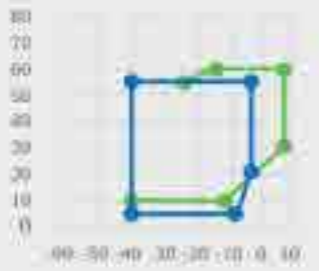
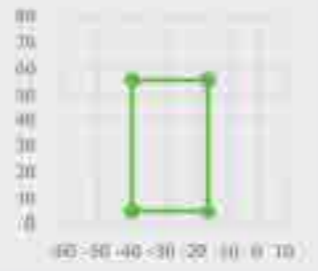
Note: \* X-axis: Evaporating temp (°C)  
 Y-axis: Condensing temp (°C)

# Low Temperature Compressor Line-up

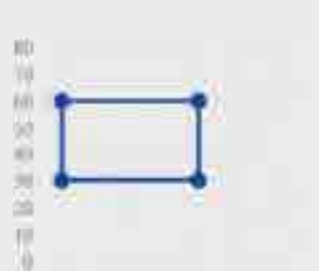
	ZF	ZFI	CF K6	Fusion	Copeland Stream	Copeland Two-Stage
						
<b>Envelope*</b>	 ZF06-18KQE, ZFI20-26KQE ZF25-41KQE, ZFI36-59KQE	 ZF49-54KQE, ZFI68-81KQE				
<b>Type</b>	Scroll	Scroll	Hermetic reciprocating	Semi-hermetic scroll	Semi-hermetic reciprocating	Semi-hermetic reciprocating
<b>Range (HP)</b>	2 - 17 HP	4 - 40 HP	1.5 - 3 HP	11 - 20 HP	5 - 45 HP	15 - 30 HP
<b>Range (kW)</b>	1.6-12.8 kW	4.6-30.3 kW	1.2-3.1 kW	6.5 - 11.2 kW	12.6 - 33.3 kW	14.1 - 26.2 kW
<b>Refrigerant</b>	R22, R404A, R448A, R449A, R407(A,C,F)	R22, R404A, R448A, R449A, R407(A,C,F)	R22, R404A, R448A, R449A	R22, R404A	R22, R134a, R404A, R407C	R22, R404A
<b>Designed for</b>	Low temp	Low temp	Low temp	Medium temp low temp	Medium temp low temp	Blast Freezing
<b>Description</b>	Highly-reliable liquid injection scroll Scroll compliance mechanism makes it highly tolerant of liquid slugging	Best-in-class efficiency with vapor injection scroll Wide envelope (-40°C to +7°C)	Highly-efficient and reliable US design for LT (37°C to -12°C)	Design for both MT and LT. fusion compressors deliver efficient and quiet performance	Rugged and reliable with industry-leading efficiency through Discus valve. CoreSense for advance diagnostics	Designed for blast chilling applications with evaporating temp between -20°C to -60°C

Capacity Conditions:  
 Medium Temp: Evaporating Temp -6.7°C, Condensing Temp 48.9°C Suction Gas 18.3°C, 50Hz, R404A  
 Low Temp: Evaporating Temp -31.7°C, Condensing Temp 40.6°C Suction Gas 18.3°C, 50Hz, R404A

Note: \* X-axis: Evaporating temp (°C)  
 Y-axis: Condensing temp (°C)

# Copeland Scroll Compressor



Copeland Scroll ZB Refrigeration Compressor

## The industry's go-to compressor

Every Copeland compressor is engineered and tested for ultra-reliability, quiet operation with improving the technology to meet today's energy and environmental standards. Over 10 million units sold across Asia Pacific demonstrates its reputation.

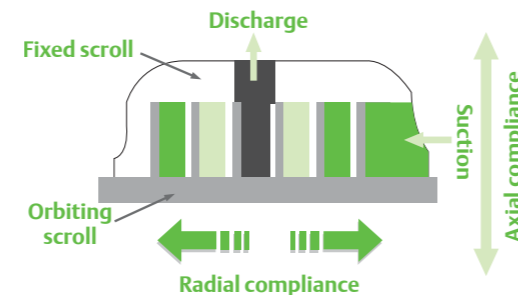
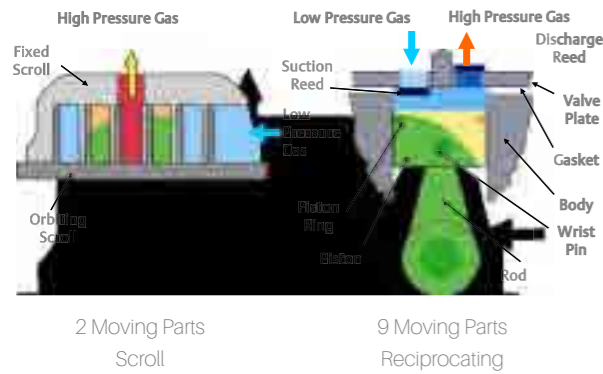

## Robust design

Scroll compressor's distinct design minimizes moving parts increases durability



## Longer product life and operation

Scrolls are designed to "wear-in" compared to other compressor technologies that "wear-out"



## Compact sizing

Lightweight and compact

## Improved liquid and debris handling

Axial and radial compliance improves compressor performance reducing system damage



## Low sound & vibration

Compression process in a scroll set is symmetrical and continuous, inherently reduces the sound, vibration and pulsation.



## Higher efficiency

Optimized for seasonal efficiency; +20% more efficient than traditional reciprocating compressor

(Available with R22, R404A, R134a)	Capacity (kW)	Motor Code	PFV	PFJ	TFD/TWD	TFM/TWM	TF5/TW5	TF7
		50 Hz	1Ø-200v	1Ø-220/240v	3Ø-380/420v	3Ø-380/420v	3Ø-200/220v	
		60 Hz	1Ø-208/230v	1Ø-265v	3Ø-380/460v		3Ø-200/230v	3Ø-380v
		HP						

ZB Refrigeration Scroll								
ZB15K	3.4	2 HP	x	x	x		x	x
ZB19K	4.4	2.5 HP	x	x	x		x	x
ZB21K	5.3	3 HP	x	x	x		x	x
ZB26K	6.2	3.5 HP	x	x	x		x	x
ZB29K	7.2	4 HP	x	x	x		x	x
ZB38K	9.0	5 HP			x		x	x
ZB45K	10.6	6 HP			x		x	x
ZB48K	11.6	6.5 HP			x		x	x
ZB58K	14.0	8 HP			x		x	x
ZB66K	15.8	9 HP			x		x	x
ZB76K	18.8	10 HP			x		x	x
ZB95K	22.8	13 HP			x		x	x
ZB114K	27.0	15 HP			x		x	x
ZB130K	30.1	20 HP			x		x	x
ZB150K	36.2	22 HP			x	x		x
ZB190K	45.2	25 HP			x	x		x
ZB220K	55.9	30 HP			x	x		x

Capacity Conditions: Evaporating Temp -6.7°C, Condensing Temp 48.9°C Suction Gas 18.3°C, 50Hz, R404A

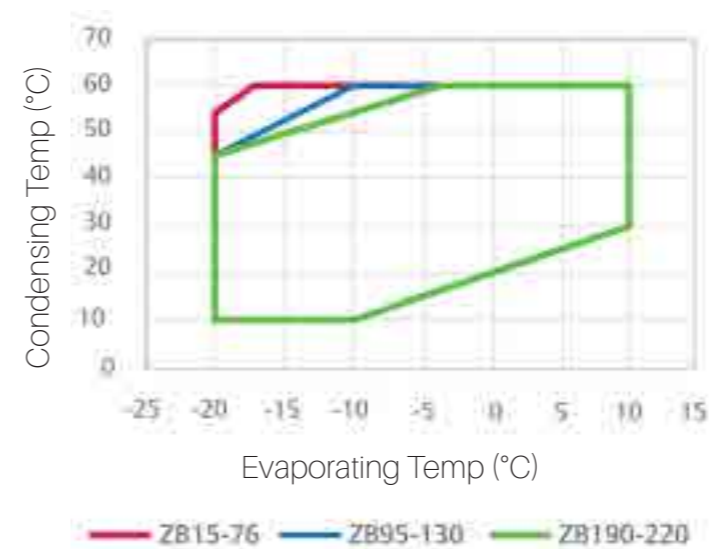

Scan to download documentation:



# Copeland Scroll with Injection Technology



Copeland Scroll ZFI Compressor with Vapor Injection

High performance refrigeration compressor

For low temperature applications with +20% efficiency gains

- ZF compressors are designed to operate with liquid injection to control discharge temperatures
- ZFI compressors are intended for operation with a sub cooler and vapor injection.

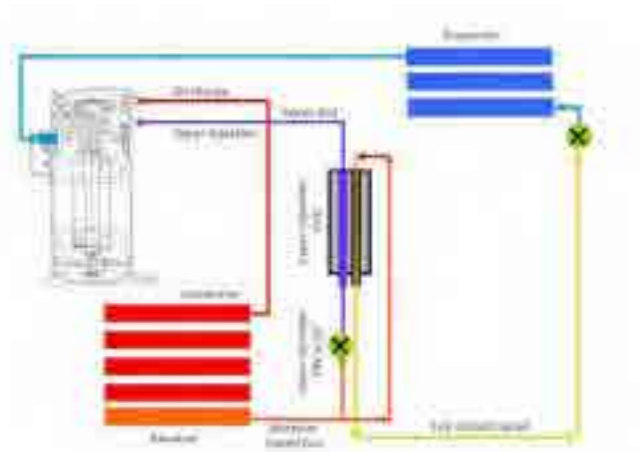

ZFI Accessory List

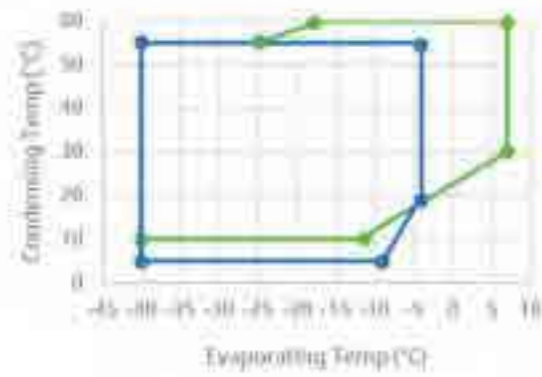

ZF06-18KQE; ZF20-26KQE  
ZF25-41KQE; ZFI36-59KQE

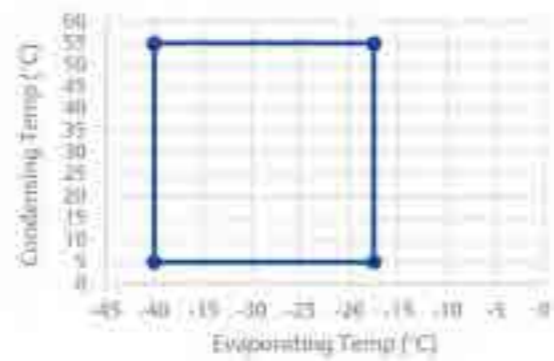

ZF49-54KQE; ZFI68-81KQE

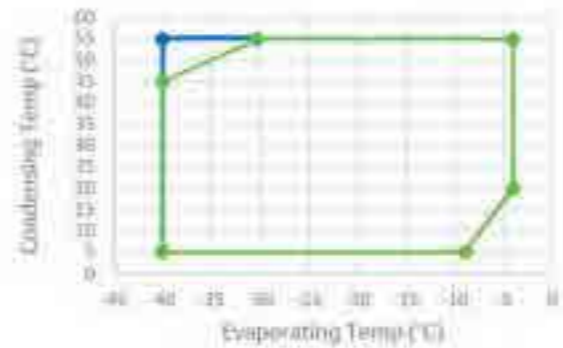

ZFI96-122KQE (20°C Return Gas)  
ZFI96-122KQE (20K Superheat)

Model (Available with R22, R404A, R448A, R449A, R507, R407A/C)	Capacity (kW)	Motor Code	TFD/ TWD/ TED	TFC/TEC	TF5/TW5	TF7/TE7
		50 Hz	3Ø-380/420v	3Ø-200v	3Ø-200/220v	
		60 Hz	3Ø-380/460v	3Ø-208/230v	3Ø-200/230v	3Ø-380v
HP						

ZF - Liquid Injection Scroll						
ZF06K	1.6	2 HP	x		x	
ZF08K	2.0	2.5 HP	x		x	
ZF09K	2.2	3 HP	x		x	
ZF11K	2.8	3.5 HP	x		x	
ZF13K	3.2	4 HP	x	x	x	x
ZF15K	3.9	4 HP	x	x	x	x
ZF18K	4.8	6 HP	x	x		x
ZF25K	5.9	7.5 HP	x	x		x
ZF28K	6.7	9 HP	x	x		x
ZF34K	7.8	10 HP	x	x		x
ZF41K	9.8	13 HP	x	x		x
ZF49K	11.8	15 HP	x	x		x
ZF54K	12.8	17 HP	x	x		x

ZFI - Vapor Injection Scroll						
ZFI20K	4.6	4 HP	x	x		x
ZFI23K	5.8	5 HP	x	x		x
ZFI26K	6.9	6 HP	x	x		x
ZFI36K	8.7	7.5 HP	x	x		x
ZFI39K	9.9	9 HP	x	x		x
ZFI50K	11.6	10 HP	x	x		x
ZFI59K	14.1	13 HP	x	x		x
ZFI68K	16.0	15 HP	x	x		x
ZFI81K	18.8	20 HP	x	x		x
ZFI96K	24.1	25 HP	x	x		x
ZFI122K	30.3	30 HP	x	x		x
ZFI140K	TBC	40 HP	Q4'21	Q4'21		Q4'21

Capacity Conditions:  
Evaporating Temp -31.7°C; Condensing Temp 40.6°C Suction Gas 18.3°C; 50Hz; R404A

Scan to download documentation:



# Copeland scroll with Digital Modulation

## Simple and cost-effective mechanical modulation

Simple and cost-effective mechanical modulation

- Wide capacity range from 10% to 100%
- No inverter loss & motor switching loss
- No EMC/EMI issues
- Easy installation



Copeland Scroll Digital ZB Compressor

Fixed-speed

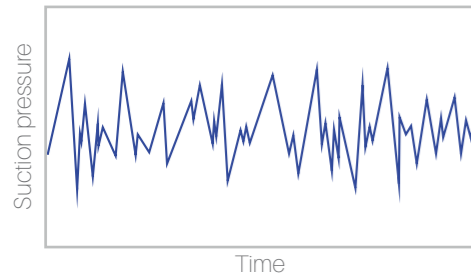

Digital modulation

Smooth operation across loads

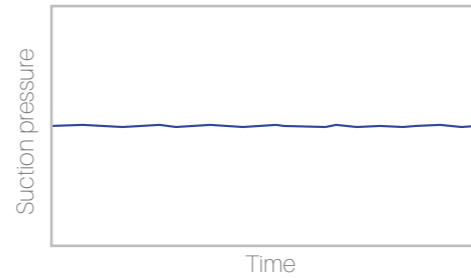

Model (Available with R22, R404A)	Capacity (kW)	Motor Code	TFD/TWD	TF5/TW5	TF7
		50 Hz	3Ø-380/420v	3Ø-200/220v	
		60 Hz	3Ø-380/460v	3Ø-200/230v	3Ø-380v
		HP			
ZBD21	5.1	3 HP	x	x	x
ZBD29	6.8	4 HP	x	x	
ZBD38	8.6	5 HP	x	x	x
ZBD45	10.2	6 HP	x	x	x

Capacity Conditions:  
(1) Evaporating Temp -6.7°C; Condensing Temp 48.9°C Suction Gas 18.3°C; 50Hz; R404A

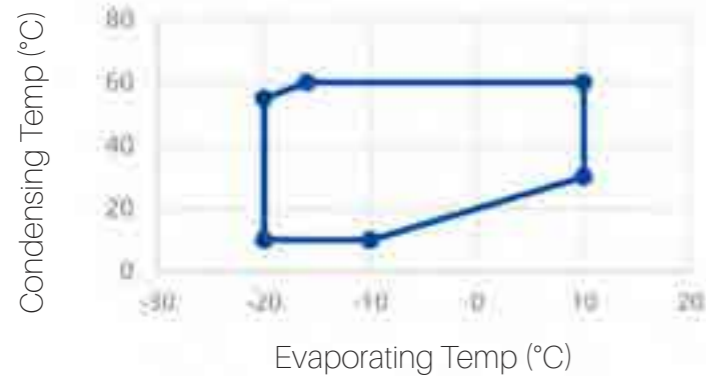

Scan to download documentation:



# Copeland ZSI Compressor

Flexible liquid injection scroll compressor

Designed for medium temp and extended medium temp applications

Flexible choice for customers looking to simplify their line-up



Copeland Scroll ZSI Compressor

Model (Available with R22, R404A)	Capacity <sup>1</sup> (kW)	Capacity <sup>2</sup> (kW)	Motor Code	TFM	PFZ
			50 Hz	3Ø-380/420v	1Ø-220/240v
			60 Hz		
			HP		
ZSI06KQE	3.7	2.0	2 HP	x	x
ZSI08KQE	4.5	2.6	2.5 HP	x	x
ZSI09KQE	4.9	2.9	3 HP	x	
ZSI11KQE	6.4	3.5	3.5 HP	x	
ZSI14KQE	8.1	4.5	4 HP	x	
ZSI15KQE	9.1	5.1	5 HP	x	
ZSI18KQE	11.1	6.3	6 HP	x	
ZSI21KQE	12.4	7.0	7.5 HP	x	

Capacity Conditions:  
(1) Evaporating Temp -6.7°C; Condensing Temp 48.9°C Suction Gas 18.3°C; 50Hz; R404A  
(2) Evaporating Temp -25°C; Condensing Temp 40.6°C Suction Gas 18.3°C; 50Hz; R404A

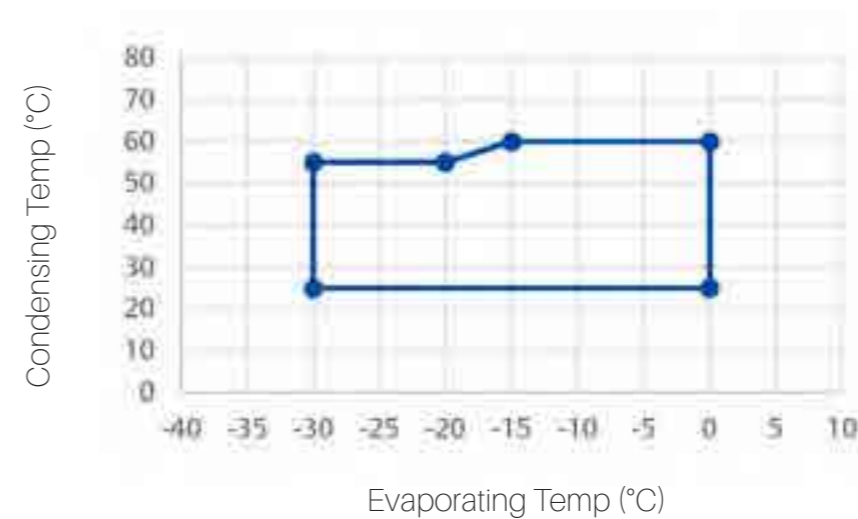

Scan to download documentation:



# Copeland Semi-Hermetic Compressor



Copeland Stream Compressor with Electronic Protection Module

## Copeland Discus high efficiency and capacity refrigeration solution

These Compressors are world renowned for its ruggedness, reliability and superior energy efficiency. Manufactured in one of the most advanced facilities in Europe, Discus compressors feature advanced protection and diagnostics for system reliability, reduced service costs and increased system uptime. Discus series compressors are built to last for today's commercial refrigeration industry.

### Industry-leading efficiency

- Discharge "puck" retained flush with valve plate  
Reduces clearance volume to minimum when piston in high position
- Valve plate allows gas to flow into cylinders with minimum heat gain  
Suction cavities designed to smoothly route the gas to minimize losses
- Superior capacity and efficiency.  
Compared to conventional compressors



Copeland Compressor Electronics Module

### Standard Compressor Discharge "Reed"



Discharge "Reed"

Re-expansion volume

### Copeland Discus Integrated Discharge "Puck" Valve



Discharge "Puck"

No dead volume (Re-expansion)

### Increase your uptime

Key features such as fault history and LED indicators allow technicians to diagnose past and present system statistics for rapid and accurate troubleshooting. When the compressor electronics detect a fault, it will respond by shutting down the compressor to avoid imminent damage.

Model (Available with R22, R404A and R407C, R134a)	Medium Temp Capacity (kW)	Low Temp Capacity (kW)	Motor	AWM	EWL	AWD	EWK
			50 Hz	3Ø-380/420v	3Ø-230v 3Ø-400v		
			60 Hz			3Ø-460v	3Ø-230v 3Ø-380v
			Motor HP				
Medium Temp Optimized							
2DC-50X	8.3	2.6	5 HP	x	x	x	x
2DD-50X	10.2	3.4	5 HP	x	x	x	x
2DL-75X	12.9	4.4	7.5 HP	x	x	x	x
2DB-75X	15.4	5.8	7.5 HP	x	x	x	x
3DA-75X	18.1	6.4	7.5 HP	x	x	x	x
3DC-100X	21.5	8.0	10 HP	x	x	x	x
3DS-150X	28.8	10.9	15 HP	x	x	x	x
4MA-22X	34.2	12.7	22 HP	x	x	x	x
4MH-25X	40.4	14.9	25 HP	x	x	x	x
4MI-30X	44.6	17.3	30 HP	x	x	x	x
4MJ-33X	49.7	19.2	33 HP	x	x	x	x
4MK-35X	55.8	21.6	35 HP	x	x	x	x
6MJ-45X	75.0	28.8	45 HP	x	x	x	x
6MK-50X	84.5	32.5	50 HP	x	x	x	x
Low Temp Optimized							
2DL-40X	12.6	4.5	4 HP	x	x	x	x
2DB-50X	15.3	5.5	5 HP	x	x	x	x
3DA-50X	17.0	6.7	5 HP	x	x	x	x
3DC-75X	20.6	8.2	7.5 HP	x	x	x	x
3DS-100X	28.4	11.3	10 HP	x	x	x	x
4MF-13X	33.0	12.6	13 HP	x	x	x	x
4ML-15X	40.2	15.7	15 HP	x	x	x	x
4MM-20X	43.6	17.7	20 HP	x	x	x	x
4MT-22X	49.9	19.8	22 HP	x	x	x	x
4MU-25X	-	21.8	25 HP	x	x	x	x
6MM-30X	67.3	26.5	30 HP	x	x	x	x
6MT-35X	75.9	29.9	35 HP	x	x	x	x
6MU-40X	85.4	33.3	40 HP	x	x	x	x

Capacity Conditions:

MT Conditions: Evaporating Temp -6.7°C; Condensing Temp 48.9°C Suction Gas 18.3°C; 50Hz; R404A

LT Conditions: Evaporating Temp -31.7°C; Condensing Temp 40.6°C Suction Gas 18.3°C; 50Hz; R404A

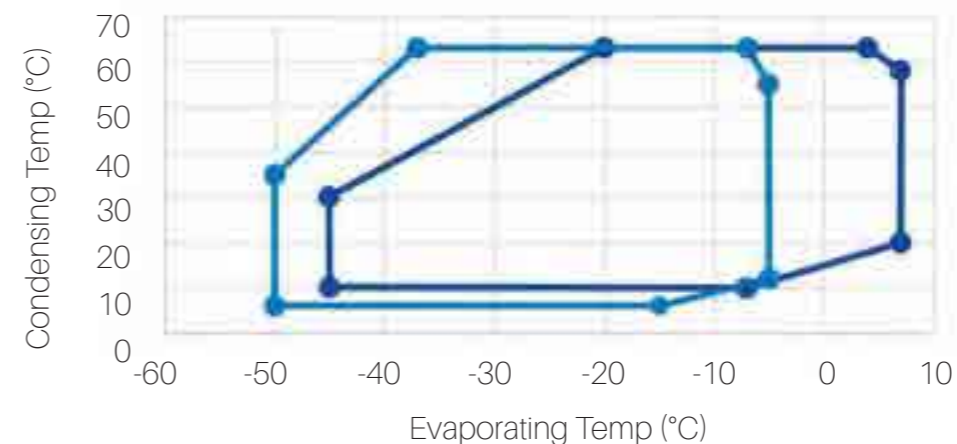

Scan to download



Product Selector Software

# Copeland Semi-Hermetic K/L Compressors

Models (Available with R22, R134a, R404A and R407C)	Motor	EWL	EWK
	50 Hz	3Ø 380-420v	
	60 Hz		3Ø 380-420v
	Capacity (kW)		
<b>Medium Temp</b>			
KM-7X	2.3	x	x
KJ-10X	3.1	x	x
KSJ-15X	3.9	x	x
KL-20X	4.6	x	x
LE-20X	5.6	x	x
LF-30X	8.0	x	x
LJ-30X	8.8	x	x
LL-40X	11.5	x	x
<b>Low Temp</b>			
KM-7X	0.8	x	x
KM-5X	0.8	x	x
KJ-10X	1.1	x	x
KJ-7X	1.1	x	x
KSJ-15X	1.4	x	x
KSJ-10X	1.5	x	x
KL-20X	1.6	x	x
LE-20X	1.7	x	x
KL-15X	1.7	x	x
KSL-20X	2.1	x	x
LF-20X	2.3	x	x
LF-30X	2.7	x	x
LJ-20X	2.8	x	x
LJ-30X	3.1	x	x
LL-30X	3.9	x	x
LL-40X	3.9	x	x

Capacity Conditions:

MT: Evaporating Temp -6.7°C; Condensing Temp 48.9°C Suction Gas 18.3°C; 50Hz; R404A

LT: Evaporating Temp -31.7°C; Condensing Temp 40.6°C Suction Gas 18.3°C; 50Hz; R404A





# Copeland Hermetic Integral Horsepower Reciprocating Compressors



CS Hermetic reciprocating compressor

## High-tier reciprocating compressor

Best in class reciprocating hermetic solutions from 1.5 HP To 3.5 HP.

Supports a wide range of applications from cabinets, island freezers, cold rooms, and bulk milk chilling.

- Highly reliable based on over 10 years of project installations
- Value option versus scroll compressors
- Extended medium temperature envelope

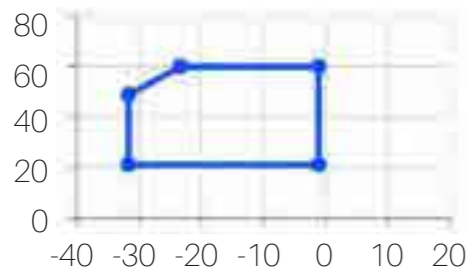

### CS K6 Platform

Based on proven US design

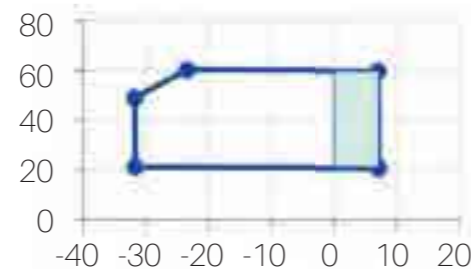

### CS K7 Platform

Enhance envelope version of CSK6 to support pull down application

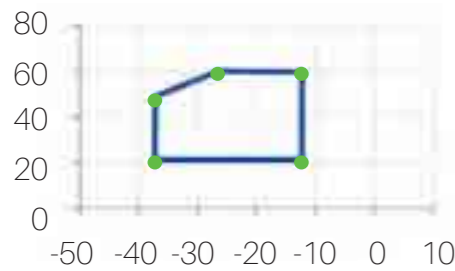

### CF K6 Platform

Based on proven US design support for low temperature

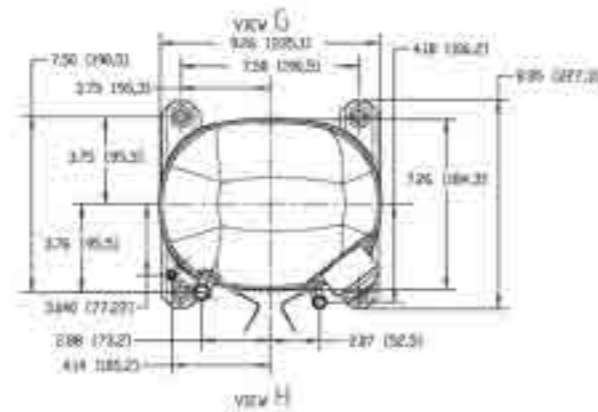

### Industry-standard 7.5 x 7.5 leg

Same as previous generation platform such as CR\*K6 and KCM



### Protection

CSK6 and CFK6 standard sight glass and crankcase heater

Model (Available with R22, R406A)	Motor Code	PFV	PFZ	TFD	TFM	TF5
	50 Hz	1Ø-200v	1Ø-220/240v	3Ø-380/420v	3Ø-380/420v	3Ø-200/240v
	60 Hz	1Ø-208/230v		3Ø-380/460v		3Ø-200/230v
	Capacity (kW)					
CSK6 Platform						
CS10K6	2.5	x	x		x	x
CS11K6	2.7		x	x		
CS12K6	2.8	x		x		x
CS13K6	3.3		x		x	
CS14K6	3.5	x		x		x
CS16K6	3.9		x			
CS17K6	4.1		x		x	
CS18K6	4.2	x		x		x
CS20K6	4.8	x	x	x	x	x
CS24K6	5.4			x		
CS25K6	5.8		x			
CS27K6	6.4	x		x		x
CS30K6	7.1			x	x	
CS33K6	7.5	x		x		x
CFK6 Platform						
CF04K6	0.9	Sept '21				Sept '21
CF05K6	0.9		Sept '21		Sept '21	
CF06K6	1.6	Sept '21		Sept '21		Sept '21
CF09K6	2.4	Sept '21		Sept '21		Sept '21
CF10K6	2.4				Sept '21	
CF12K6	3.1	Sept '21		Sept '21		Sept '21
CSK7 Platform*						
CS10K7	2.5	x	x		x	
CS11K7	2.7					
CS12K7	2.9	x		x		x
CS13K7	3.3		x		x	
CS17K7	4.1		x		x	
CS18K7	4.2	x		x		x
CS20K7	4.8		x		x	
CS24K7	5.4	x		x		x
CS23K7	7.5	x		x		x

Capacity Conditions:

MT Conditions: Evaporating Temp -6.7°C; Condensing Temp 48.9°C Suction Gas 18.3°C; 50Hz; R404A

LT Conditions: Evaporating Temp -31.7°C; Condensing Temp 40.6°C Suction Gas 18.3°C; 50Hz; R404A

Scan to download documentation:



# Copeland CR Integral Horsepower Compressors



## Cost Efficient Compressor

An economical hermetic solution from 1.5 To 6.5 HP

Model (Available with R22, R407C)	Capacity (kW)	Motor Code	PFV	PFV/PF1	TFD	TFM	TF5
		50 Hz	1Ø-200v	1Ø-220/240v	3Ø-380/420v	3Ø-380/420v	3Ø-200/240v
		60 Hz	1Ø-208/230v		3Ø-380/460v		3Ø-200/230v
		HP					
CR20K6	2.8	1.5 HP	x				
CR22K6	2.8	1.5 HP		x		x	
CR24K6	3.3	2 HP	x	x	x		x
CR28K6	3.3	2 HP	x				
CR30K6	4.0	2.5 HP		x		x	
CR32K6	4.2	2.5 HP	x	x			
CR34K6	4.7	3 HP	x	x	x		x
CR36K6	4.8	3 HP		x		x	
CR37K6	5.0	3.25 HP	x	x	x		x
CR42K6	5.7	3.5 HP	x	x		x	x
CR47KQM	7.2	4 HP	x	x	x		x
CR53KQM	7.9	4.5 HP	x		x		x
CR57KQM	8.0	4.5 HP	x		x		x
CR62KQM	9.2	5 HP	x		x		x
CR72KQM	12.8	6.5 HP	x			x	

Conditions:  
Evaporating Temp -6.7°C, Condensing Temp 48.9°C Suction Gas 18.3°C, 50Hz, R22

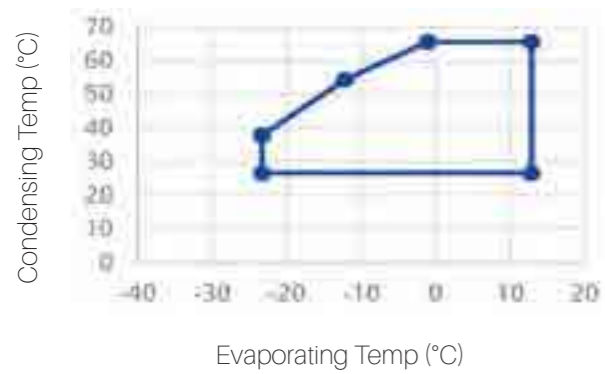

Scan to download documentation:



# Copeland Hermetic Fractional Horsepower Reciprocating Compressors



Bottle Coolers



Glass Top Freezer

Compact and efficient refrigeration compressor

Designed and manufactured for efficiency and reliability, Copeland compressors are the proven choice for various food service applications



## KCE & KCJ Platform

Proven reliability & cost-effective platform with over 40 years of field installations across Asia



## KCN Platform

Mid-generation platform balances efficiency and cost effectiveness



## ECZ Platform

High efficiency platform delivering up to 20% higher EER compared with standard model; Available with R290



Ice Cream Machine



Water Dispenser



Display Counter



Drinking Water Cooler



Food Cart

Platform	Ref.	Model (50Hz)	Displacement (cc)	Capacity (btu/Hr)	EER	Capacity (watt)	
<b>High Temperature Models</b>							
KCE	R134a	KCE419HAG-VXXXH	5.8	1,585	6.5	465	
		KCE425HAG-VXXXH	7.6	2,145	6.0	629	
		KCE432HAG-SXXXH	9.4	2,690	7.2	788	
		KCE444HAG-VXXXH	12.1	3,675	8.2	1,077	
	R22	KCE443HAE-VXXXH	8.0	3,450	7.7	1,011	
		KCE461HAE-VXXXH	11.5	5,100	8.2	1,495	
ECZ	R134a	ECZ421HG-13F-37XX	5.3	1,700	7.1	498	
		ECZ426HG-11M-37XX	6.0	2,150	9.0	630	
		ECZ426HG-13M-37XX	6.0	2,150	9.0	630	
		ECZ431HG-11M-37XX	7.2	2,555	9.0	749	
		ECZ431HG-13M-37XX	7.2	2,555	8.6	749	
		ECZ434HG-11M-37XX	8.7	3,150	9.4	923	
		ECZ434HG-13M-37XX	8.7	3,150	9.4	923	
		ECZ444HG-11M-37XX	10.5	3,700	9.0	1,084	
		ECZ444HG-13M-37XX	10.5	3,700	9.0	1,084	
		ECZ463HG-11M-37XX	15.3	5,250	8.8	1,539	
		KCN	R134a	KCN463HAG-UXXXH	15.3	5,250	8.5
KCJ	R134a	KCJ443HAG-BXXXH	12.6	3,700	8.2	1,084	
		KCJ467HAG-BXXXH	18.3	5,600	8.3	1,641	
		KCJ482HAG-SXXXH	22.0	7,075	8.5	2,073	
		KCJ498HAG-SXXXH	25.9	8,200	8.4	2,403	
		KCJ511HAG-UXXXH	29.3	9,290	8.8	2,723	
		KCJ513HAG-SXXXH	38.0	12,135	8.6	3,556	
		R22	KCJ511HAE-UXXXH	18.3	9,150	9.0	2,682
			KCJ513HAE-SXXXH	25.9	12,800	8.9	3,751
	<b>Low Temperature Models</b>						
	KCN	R134a	KCN372LAG-BXXXH	7.3	600	3.8	176
KCN396LAG-BXXXH			9.0	800	3.9	234	
KCN411LAG-BXXXH			11.1	960	3.9	281	
KCN415LAG-BXXXH			15.3	1,260	3.9	369	
R404A		KCN414LAL-BXXXH	7.3	1,150	3.5	337	
		KCN418LAL-BXXXH	9.0	1,500	4.0	440	
		KCN422LAL-BXXXH	11.1	1,825	4.0	535	
		KCN430LAL-BXXXH	15.3	2,575	4.4	755	
		ECZ380LG-11M-37XX	7.2	660	4.6	193	
		ECZ380LG-13M-37XX	7.2	660	4.3	193	
ECZ	R134a	ECZ396LG-11M-37XX	8.2	760	4.3	223	
		ECZ396LG-13M-37XX	8.2	760	4.0	223	
		ECZ411LG-11M-37XX	10.5	890	3.9	261	
		ECZ416LG-11M-37XX	13.8	1,260	4.5	369	
		ECZ416LG-13M-37XX	13.8	1,260	4.5	369	
	R404A	ECZ412LL-31M-37XF	6.4	984	4.5	288	
		ECZ417LL-31M-37XF	8.7	1,318	4.5	386	
		ECZ419LL-31M-37XF	9.9	1,642	4.9	481	
	R290	ECZ410LH-31M-X7XF	6.2	890	5.0	261	
		ECZ412LH-11M-X7XF	7.2	1,090	5.0	319	
		ECZ415LH-31M-37DF	8.7	1,220	4.9	358	
KCE	R134a	KCE334LAG-AXXXH	4.5	285	2.6	84	
		KCE345LAG-BXXXH	5.5	380	2.8	111	
KCJ	R134a	KCJ412KLAG-BXXXH	16.4	1,025	3.7	300	
		KCJ423KLAG-CXXXH	32.6	1,925	4.0	564	
	R404A	KCJ430LAL-BXXXH	16.4	2,425	4.2	711	
		KCJ450LAL-BXXXH	32.6	4,100	4.1	1,202	

Capacity Conditions:

High Temp: 7.2°C Evaporating Temp / 54.4°C Condensing Temp / 35°C Return Gas / 8.34K Subcooling/ 50Hz

Low Temp: -23.3 °C Evaporating Temp / 54.4°C Condensing Temp / 35°C Return Gas / 8.34K Subcooling/50Hz



# Contact lists

## Asia Pacific Headquarters

Suite No. 2503-10A, 25/F,  
Exchange Tower, 33 Wang Chiu Road,  
Kowloon Bay, Kowloon, Hong Kong  
Tel: (852) 2866 3108  
Fax: (852) 2520 6227

## Australia

356 Chisholm Road  
Auburn NSW 2144, Australia  
Tel: (612) 9795 2800  
Fax: (612) 9738 1699

## China - Beijing

Room 1203-1205,  
North Wing Junefield Plaza Central Tower,  
No. 10 Xuan Wu Men Wai Street,  
XiCheng District, Beijing, PRC  
Tel: (8610) 5095 2188

## China - Guangzhou

Guangzhou Office  
Unit 2202B, 22/F, Leatop Plaza,  
32 Zhujiang East Road, Tianhe Dist.,  
Guangzhou 510623, PRC  
Tel: (8620) 8595 5188

## China - Shanghai

Shanghai Sales Office  
7F, Emerson Building, 1582 Gumei  
Rd, Shanghai, PRC  
Tel: (8621) 3338 7333

## India - Mumbai

Delphi B-Wing, 601-602, 6th Floor  
Central Avenue,  
Hiranandani Business Park,  
Powai, Mumbai 400076, India  
Tel: (9122) 6786 0793  
Fax: (9122) 6662 0500

## India - Pune

Plot No. 23, Rajiv Gandhi Infotech Park,  
Phase - II, Hinjewadi,  
Pune 411 057, Maharashtra, India  
Tel: (9120) 4200 2000  
Fax: (9120) 4200 2099

## Japan

Shin-yokohama Tosho Building  
No. 3-9-5 Shin-Yokohama, Kohoku-ku  
Yokohama 222-0033 Japan  
Tel: (8145) 475 6371  
Fax: (8145) 475 3565

## Middle East & Africa

PO Box 26382  
Jebel Ali Free Zone - South  
Dubai, UAE  
Tel: (9714) 811 8100  
Fax: (9714) 886 5465

## Philippines

10/F SM Cyber West Avenue, EDSA cor.  
West Avenue, Barangay Bungad,  
Diliman, Quezon City 1105 Philippines  
Tel: (632) 689 7200

## Saudi Arabia

PO Box 34332 - 3620 Building 7874  
Unit 1, 67th street 2nd Industrial City  
Dammam, Saudi Arabia  
Toll Free: 800 844 3426  
Tel: +966 3 8147560  
Fax: +966 3 8147570

## South Korea

3F, The Pinnacle Gangnam  
343, Hakdong-ro, Gangnam-gu,  
Seoul 06060, Republic of Korea  
Tel: (822) 3483 1500  
Fax: (822) 592 7883

## Thailand

34th Floor, Interlink Tower,  
1858/133, Bangna Trad,  
Bangkok 10260, Thailand  
Tel: (662) 716 4700  
Fax: (662) 751 4241

## United Arab Emirates

Jebel Ali Free Zone  
PO Box 26382  
Dubai UAE  
Toll Free: 800 441 3428  
Tel: +971 4 811 8100  
Fax: +971 4 886 5465