

MRLDS-250

Infrared Gas Detector

Installation and Operation User Manual



Copeland
1065 Big Shanty Road NW, Suite 100
Kennesaw, GA 30144 USA
770-425-2724 • 1-800-829-2724
www.copeland.com
Email: ColdChain.TechnicalServices@copeland.com

1 INTRODUCTION..... 1

1.1 Overview 1

1.2 Detection Options 1

 1.2.1 Broadband vs. Gas Specific 1

 1.2.2 Broadband Gas Detection 1

 1.2.3 Detecting Specific Gases 2

1.3 Remote Controller Options 3

1.4 Parts List 3

1.5 Specifications 4

2 MOUNTING THE GAS DETECTOR..... 5

2.1 Warnings and Prerequisites 5

2.2 Mounting Locations 5

 2.2.1 General Placement Guidelines 5

 2.2.2 Machinery Rooms 6

 2.2.3 Refrigerated Spaces 6

 2.2.4 Chillers 6

2.3 Mounting Procedure 6

3 WIRING AND CONFIGURATION..... 8

3.1 Overview 8

3.2 Wiring Supply Power (24VAC or 24VDC) 8

3.3 Wiring Alarm Output (Analog Signal) 9

3.4 Wiring the Digital Alarm Output Relay 9

3.5 MODBUS Network Configuration 10

3.6 Finish Installation 11

4 OPERATION AND STABILIZATION..... 12

4.1 Power Up and Warm-up 12

4.2 Stabilization 12

4.3 Perform a Manual Zero 12

4.4 Alarms 12

4.5 Gas Detector Faults..... 13

 4.5.1 Overview 13

 4.5.2 Non-Critical Faults 13

 4.5.3 Critical Faults 13

5 CONFIGURE THE GAS DETECTOR..... 14

5.1 User Interface Overview 14

5.2 Setting Parameters 14

 5.2.1 Overview 14

 5.2.2 Configuration Parameters 14

5.3 Completing Setup 18

6 FUNCTIONAL TESTS AND ADJUSTMENTS..... 19

6.1 Introduction 19

6.2 Bump Testing vs. Adjusting Detector Response..... 20

6.3 Bump Testing 20

6.4 Adjustment Using Calibration Gas..... 21

7 MODBUS COMMUNICATIONS 23

7.1 Introduction..... 23

7.2 Communications Settings 23

7.3 Analog Input Registers 23

7.4 Analog Output Registers..... 24

7.5 Input Status Flags..... 25

7.6 Output Status Flags 25

8 TROUBLESHOOTING..... 26

8.1 Fault Codes..... 26

8.2 Diagnostic Attributes (P.-18)..... 27

8.3 Resetting the MRLDS-250 to Default Values 28

8.4 Other Symptoms..... 29

9 REPLACEMENT PARTS AND ACCESSORIES 30

APPENDIX: E2 SETUP..... 31

1 Introduction

1.1 Overview

The MRLDS-250 NDIR (non-dispersive infrared) is a state-of-the-art fixed gas detector that can detect a wide range of refrigerant gases. The MRLDS-250 can be used on a stand-alone basis or integrated into controls or a Building Management System (BMS).

The MRLDS-250 can be used in locations that require continuous monitoring and to add gas detection solutions to an existing system.

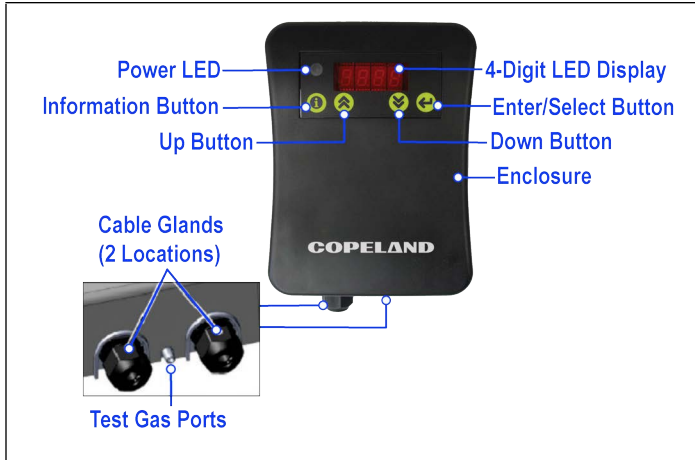

Figure 1-1 - MRLDS-250 Components

1.2 Detection Options

1.2.1 Broadband vs. Gas Specific

The MRLDS-250 NDIR refrigerant gas detectors are available in two versions: broadband and gas-specific.

1.2.2 Broadband Gas Detection

The broadband gas detector (P/N 809-0030) is used as a general purpose gross leak detector and is factory tested and certified. It is shipped from the factory with accuracy as shown in **Table 1-1** (gas dependent). If more accurate detection is needed, gas specific versions are available, which are factory certified and calibrated to the target refrigerant.

The broadband gas detector combines refrigerants into 4 groups shown in **Figure 1-2**. Measurement performance is based on an average response profile for all of the gases within the group.

Table 1-1 Broadband Gas Groups

Group #	Value for Param 11 ¹	Refrigerant	As Shipped Accuracy
1	P.-11 = 1	R134a	±25%
		R404a	±35%
		R407a	±25%
		R407c	±20%
		R407f	±20%
		R410a	±20%
		R427a	±15%
		R452B	±40%
		R507	±35%
		HFO1233ZD	±35%
2	P.1-11 = 2	R448A	±40%
		R449A	±40%
		R422a	±25%
		R422d	±20%
		HFO1234YF	±25%
		HFO1234Ze	±25%
		R452A	±25%
		R513A	±35%
R514A	±20%?		
3	P.-11 = 3	R22	±25%
4	P.-11 = 4	R32	±35%

NOTE

Greater accuracy may be achieved through the use of calibration gas and the adjustment procedure detailed in Section 6, Functional Tests and Adjustments.

¹See **Section 5, Configure the Gas Detector** for Information on Parameter 11 and other configuration instructions.

¹See **Section 5, Configure the Gas Detector** for Information on Parameter 11 and other configuration instructions.

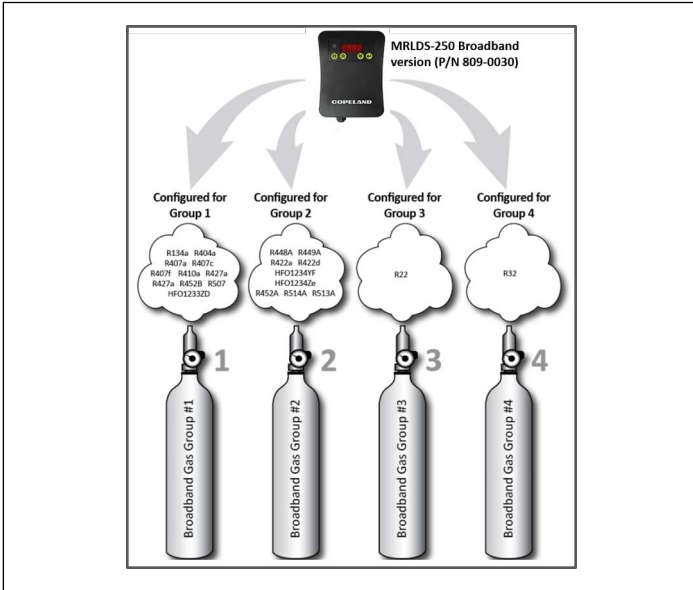

Figure 1-2 - Broadband Gas Groups 1-4

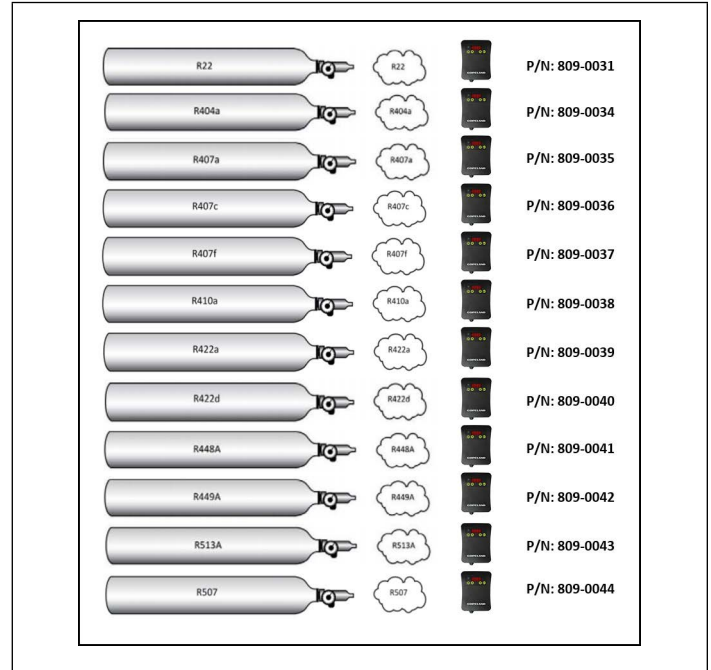

Figure 1-3 - Gas-Specific MRLDS-250 Gas Detectors

1.2.3 Detecting Specific Gases

Each gas-specific gas detector is shipped factory calibrated to its specific target refrigerant. Refer to **Figure 1-3** and **Table 1-1**.

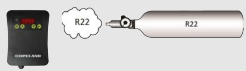

Table 1-2 Gas-specific Detector Measurement Performance

Part Number	Refrigerant ¹	Accuracy
809-0030	Broadband	±5%
809-0031	R22	±5%
809-0034	R404a	±5%
809-0035	R407a	±3%
809-0036	R407C	±3%
809-0037	R407A	±3%
809-0038	R410A	±3%
809-0039	R422A	±5%
809-0040	R422d	±5%
809-0041	R448A	±5%
809-0042	R449A	±5%
809-0043	R513A	±5%
809-0044	R507	±5%

NOTE

Copeland recommends not re-calibrating gas-specific detectors in the field to a new target gas; purchase a new gas-specific detector instead. In the event you prefer not to purchase a new gas-specific detector, use optional calibration instructions in Chapter 6 for increased accuracy when detecting a new target that is different from the “as shipped” target gas. Refer to the example in Table 1-3.

Table 1-3 Changing Gas Types and Accuracy

<p>As Shipped</p>	 <p>Part number 809-0031 (R22) is factory calibrated to R22.</p>
<p>Changed Gas Type (Reduced Accuracy)</p>	 <p>The gas detector may be changed to respond to any of the other listed refrigerants (see parameter P.-11, in Section 5.2, Setting Parameters). If changed, the gas detector will have a lower accuracy for the target refrigerant (without calibration).</p>
<p>Optional Recalibration (For Improved Accuracy)</p>	 <p>By applying calibration gas containing the new target refrigerant, and via the routine described in Section 6.4, the gas detector may then be adjusted to respond with the calibrated accuracy as shown in Table 1-2 for the new target refrigerant.</p>

1.3 Remote Controller Options

The MRLDS-250 can connect to any controller through the standard analog output (voltage and current; see **Table 1-2** for options), the standard alarm relay, or the digital Modbus RTU communications interface.

1.4 Parts List

Table 1-2 Parts List

Part Number	Description
809-0030	MRLDS-250, Broadband, 0-3, 500ppm
809-0031	MRLDS-250, Calibrated to R22, 5%
809-0034	MRLDS-250, Calibrated to R404A, 5%
809-0035	MRLDS-250, Calibrated to R407A, 3%
809-0036	MRLDS-250, Calibrated to R407C, 3%
809-0037	MRLDS-250, Calibrated to R407F, 3%
809-0038	MRLDS-250, Calibrated to R410A, 3%
809-0039	MRLDS-250, Calibrated to R422A, 5%
809-0040	MRLDS-250, Calibrated to R422D, 5%
809-0041	MRLDS-250, Calibrated to R448A, 5%
809-0042	MRLDS-250, Calibrated to R449A, 5%
809-0043	MRLDS-250, Calibrated to R513A, 5%
809-0044	MRLDS-250, Calibrated to R507, 5%
603-1100	Splash Guard
026-1315	Installation and Operation Manual

1.5 Specifications

For default values, refer to **Section 5.2, Setting Parameters**.

Table 1-3 - Specifications

Specification	Description
Power Supply	24 VDC @ 0.15 A min; 24 VAC, 5 VA min @ 50/60 Hz, 2.5 W max
Power Monitoring	Green LED
Visual Alarm	Red 4-digit LED display
Audible Alarm	Buzzer (audible alarm), enable/disable (Default enabled)
Fault Monitoring	Fault codes presented to user
Analog Outputs	4-20 mA; 0-5V; 0-10V; 1-5V; 2-10V (Default 1-5V)
Relay	1 relay rated 1 A @ 24 VAC/VDC (0.5A, 125V AC UL rating)
Range	0-3500 PPM
Squelch ¹	Readings below 75 PPM are squelched by default
Communication: MODBUS RTU over RS-485	Baud rate: 9,600 or 19,200 (selectable) Start bits: 1 Data bits: 8 Parity: None, odd, even (programmable) Stop bits: 1 or 2, programmable Retry time: 500 ms (min time between retries) End of msg; Silent 3.5 characters
Alarm Delay	Selectable: 0 to 15 minutes (Default, 0)
IP Rating	Not IP rated. An accessory splash guard is available for areas requiring additional protection from wash down.
Response Time, T90	T90 < 5 minutes
Temperature Rating	-22°F to 104°F (-30°C to 40°C)
Humidity and Elevation	5-90% relative humidity, non-condensing, 0-10,000ft. altitude
Standard Dimensions and Weights	4.0" x 5.5" x 1.5" 6.3oz. 102 x 140 x 37mm 180g
Enclosure	ABS plastic; UL flammability rating of 94V-0
Approvals	CE, MET/IEC/EN 61010-1

¹When filtering is disabled (see Configuration Parameters P.-19), the unit will respond to concentrations sub-10 PPM.

2 Mounting the Gas Detector

2.1 Warnings and Prerequisites

WARNING

Explosion hazard! Do not mount the MRLDS-250 in an area that may contain flammable liquids, vapors, or aerosols. Operation of any electrical equipment in such an environment constitutes a safety hazard.

CAUTION

The MRLDS-250 contains sensitive electronic components that can be easily damaged. Do not touch or disturb any of these component

NOTE

The mounting location of the monitor should allow it to be easily accessible for visual monitoring and servicing.

NOTE

The gas detector must be connected to a marked, suitably located and easily reached switch or circuit breaker as means of disconnection.

CAUTION

Connect monitor power and signaling terminals using wiring that complies with local electrical codes or regulations for the intended application.

CAUTION

Do NOT mount the MRLDS-250 directly to vibrating machinery as the vibrations may degrade the gas detector's performance.

2.2 Mounting Locations

2.2.1 General Placement Guidelines

NOTE

The MRLDS-250 should be installed plumb and level and securely fastened to a rigid mounting surface.

NOTE

When installed in areas that may be subjected to water spray, the optional splash guard (P/N 603-1100) should be used in conjunction with the MRLDS-250.

Gas detectors must be located within the appropriate wire lengths from the central controller (if used).

2.2.2 Machinery Rooms

There is no absolute rule in determining the number of gas detectors and their locations. However, a number of simple guidelines can help in making a decision. Gas detectors monitor a point as opposed to an area. If the gas leak does not reach the detector, no alarm will be triggered. Therefore, it is extremely important to select the gas detector location carefully. Also consider ease of access for maintenance.

The size and nature of the site can help in deciding which method is the most appropriate to use. Locations requiring the most protection in a machinery or plant room would be in close proximity to compressors, pressurized storage vessels, refrigerant cylinders, storage rooms, or pipelines. The most common leak sources are valves, gauges, flanges, joints (brazed or mechanical), and filling or draining connections.

- In machinery rooms where there is little or no airflow, placement options are:
 - **Point Detection:** where gas detectors are located as near as possible to the most likely sources of leakage, such as the compressor, expansion valves, mechanical joints, or cable duct trenches.
 - **Perimeter Detection:** where gas detectors completely surround the area or equipment.
- Halocarbon and hydrocarbon refrigerants are heavier-than-air gases and as such, the gas detectors should be located near ground level (6 to 18 inches from the floor)

NOTE

Gas detectors should be positioned just far enough back from any high-pressure parts to allow gas clouds to form and be detected. Otherwise, a gas leak might pass by in a high-speed airflow area and go undetected by the gas detector.

- Make sure that pits, stairwells, and trenches are monitored since they may fill with stagnant pockets of gas.
- For racks or chillers pre-fitted with refrigerant gas detectors, these should be mounted so as to monitor the compressors.
- Do not mount the gas detector directly to pipes or structures that are subject to strong vibration.

2.2.3 Refrigerated Spaces

In refrigerated spaces, gas detectors should be located away from doors, in the return airflow to the evaporators on a sidewall (below head-high is preferred), or on the ceiling, not directly in front of an evaporator, nor in any direct airflow. In large rooms with multiple evaporators, gas detectors should be mounted on the central line between two adjacent evaporators, as turbulence will result in airflows mixing.

2.2.4 Chillers

In the case of small water- or air-cooled enclosed chiller units, mount the gas detector to monitor airflow to the extract fans. With larger models also place a gas detector inside the enclosure under or adjacent to the compressors.

For enclosed air-cooled chillers or the outdoor unit for variable refrigerant volume and variable refrigerant flow (VRV/VRF) systems, mount the gas detector to monitor airflow to the extract fan. With large units also place a gas detector inside the enclosure under or adjacent to the compressors.

2.3 Mounting Procedure

To open the housing as received, use a flat blade screwdriver and depress the top latch. While pushing the latch, grasp the back edge of the housing near the latch and pull the back away.

When mounted, the housing is simply opened by pressing the top latch with a suitable screwdriver or other flat blade. With the top latch depressed, pull the housing apart by grasping the sides and pulling straight out. With the housing separated, the mounting base with terminal blocks will be visible. See **Figure 2-1**.

CAUTION

Do not apply caulking or other material around the gas detector base. The gas detector relies on air exchange through the spaces between the base and the gas detector housing. Do not obstruct the small gap around the housing and the base with any material.

Table 2-1 Mounting Procedures

Step	Mounting Procedure
1	Open the housing (see Figure 2-1).
2	Position the base to the pre-determined (acceptable) mounting location. Use the gas detector base to mark the mounting locations as needed. The hole pattern on the backplate is sized to mount the gas detector onto various electrical junction boxes. The other holes may be used as needed to mount the gas detector to other structures, or onto a wall.
3	For Wall Mount, attach the MRLDS-250 base to the mounting surface using two #6 screws (provided) through two of the 7 mounting holes, and be careful not to over-tighten the screws. Refer to Figure 2-2 for the locations of mounting holes on the base. For Junction Box Mount, attach the MRLDS-250 base to the junction box (using mounting hardware provided with your junction box) through the two junction box holes. Refer to Figure 2-2 for the locations of the two junction box mounting holes on the base.
4	Unless you are ready to wire the device (see Section 3, Wiring and Configuration), carefully snap the cover onto the base unit.

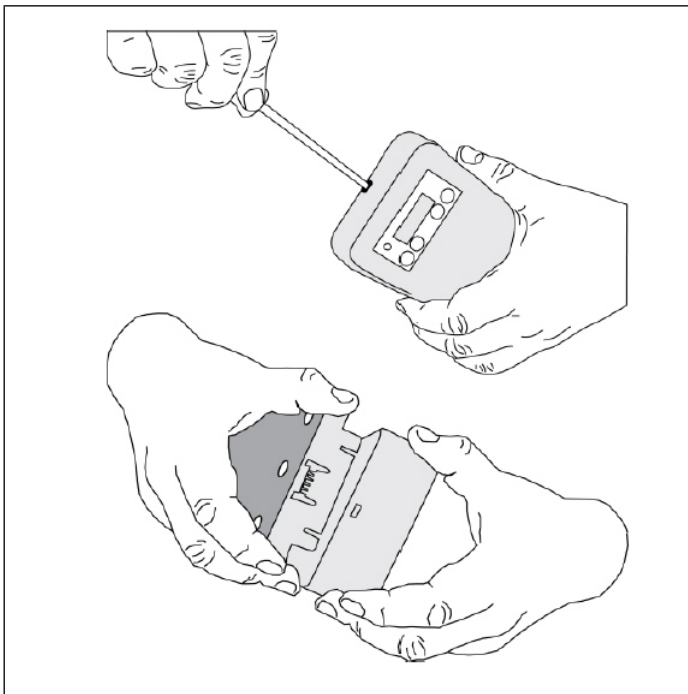

Figure 2-1 - Initial Housing Separation

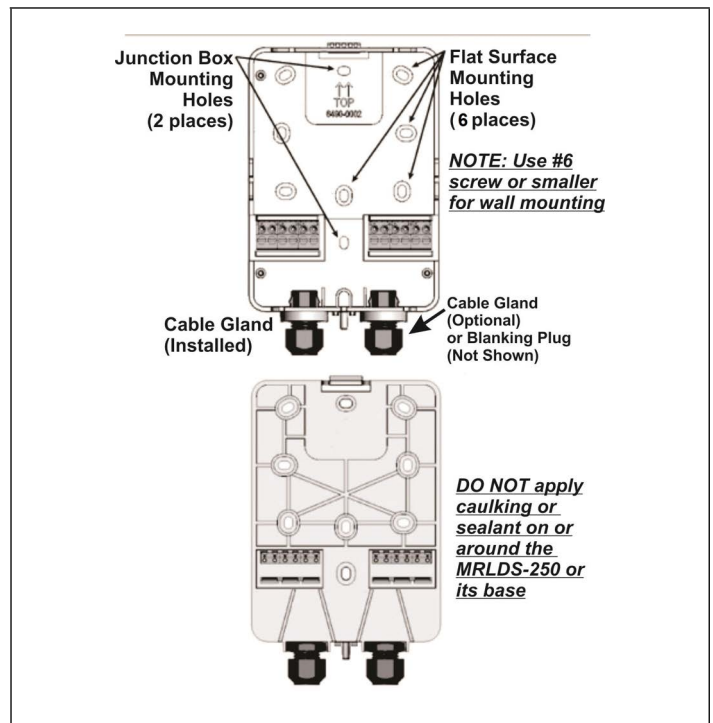

Figure 2-2 - Front and Back Views of MRLDS-250 Base

3 Wiring and Configuration

3.1 Overview

Prior to wiring and configuring the MRLDS-250, ensure the following conditions have been met:

- MRLDS-250 backplate is mounted in an appropriate location.
- The cover panel is removed.
- If the cover panel was reattached after mounting, open the gas detector enclosure by pressing the top latch with a suitable screwdriver or other flat blade. With the top latch depressed pull the housing apart by grasping the sides and pulling straight out. Align and press together to close.

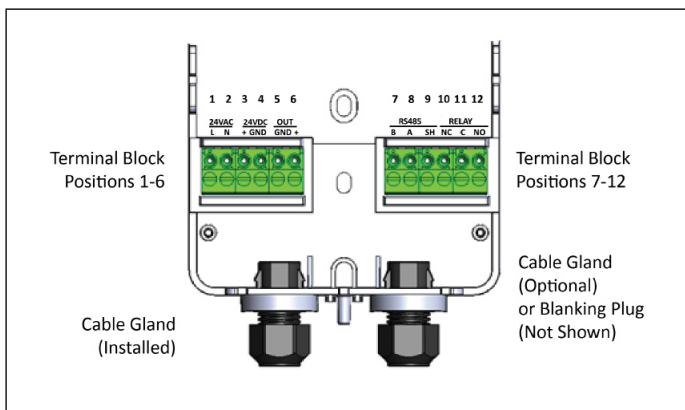

Figure 3-1 - Terminal Blocks and Cable Glands

NOTE The pre-installed cable gland (left) and the optional cable on the gland (right) have a 1/4 cable capacity (each).

NOTE Install the optional cable gland in the right side of the base unit if needed. Otherwise, install the blanking plug that is included in the mounting kit.

3.2 Wiring Supply Power (24VAC or 24VDC)

CAUTION Incorrect wiring may permanently damage the gas detector and void the warranty. Double check all terminations before applying power.

Either 24VAC or 24VDC may be used to power the MRLDS-250. Connect wiring to the appropriate terminal locations (see Table 3-1). Use two wires, between 14 and 22 AWG. Refer to Figure 3-2 for (AC wiring left) or DC wiring (right).

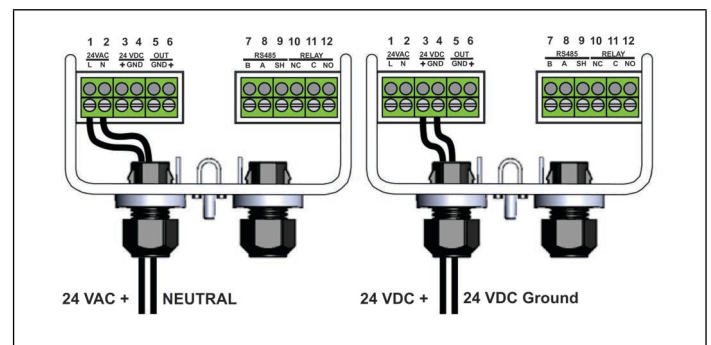

Figure 3-2 - Supply Power Wiring Options

Table 3-1 - Power Options and Terminal Block Connections

Power Option	Pin	Label	Wiring Termination
24 VAC	1	L	24V AC line
	2	N	24V AC neutral
24 VDC	3	+	24V DC positive
	4	GND	24V DC ground

WARNING The MRLDS-250 must be powered by either:

- A suitable UL 60950/CSA certified power supply that is isolated from line voltage by double insulation, or
- An appropriately rated UL listed/CSA Class 2 transformer

Failure to comply can result in personal injury or death.

WARNING Neutral polarity must be maintained across units. Refer to Figure 3-3.

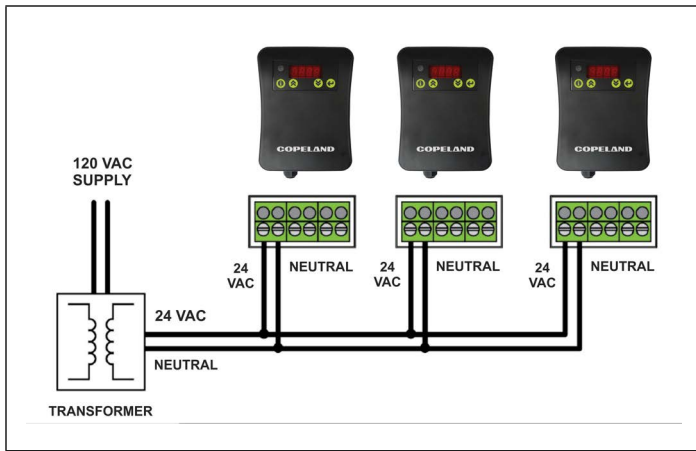

Figure 3-3 - Maintaining Neutral Polarity

3.3 Wiring Alarm Output (Analog Signal)

The MRLDS-250 provides an analog output signal that is proportional to the level of gas detected.

NOTE

No jumpers or hardware switch settings are required to configure the analog output. This is done electronically from the front panel display.

Connect two 18 to 20 AWG wires to terminal block positions 5 and 6 (see **Figure 3-4**), noting ground and signal polarity per **Table 3-2**.

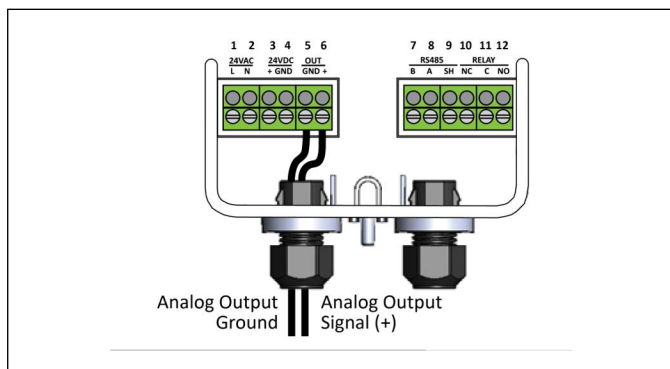

Figure 3-4 - Analog Output Wiring

Table 3-2 - Alarm Output Terminal Block Connections

Function	Pin	Wiring Termination
Analog	5	Analog output ground
Output	6	Analog output signal (+)

The type of output signal on pins 5 and 6 is programmable using the analog output type parameter P.-03. Refer to **Section 5, Configure the Gas Detector** for details.

3.4 Wiring the Digital Alarm Output Relay

An alarm setpoint may be programmed from the front panel of the MRLDS-250. When the level of the detected gas exceeds the alarm setpoint, the MRLDS-250 enters the alarm state. An on-board relay is tied to the alarm state, so you may activate (or deactivate) external equipment based on the MRLDS-250's current alarm status.

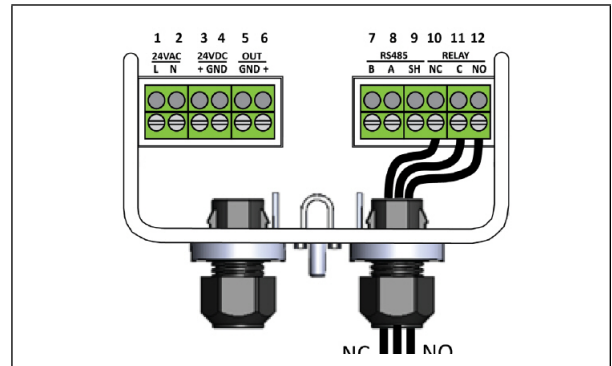

Figure 3-5 - Sample Relay Output Wiring

NOTE

The relay can be programmed to be failsafe (normally energized). By default, the relay is set to be normally de-energized. This can be set using parameter P-06

Make relay connections (NO, NC, or both) using 18 to 20 AWG wires to terminal block positions 10, 11, and 12 (see **Figure 3-5**), noting normally open, normally closed, and common connectors per **Table 3-3**.

Table 3-3 - Relay Output Terminal Block Connections

Function	Pin	Mounting Procedure
Relay (Alarm) Output	10	Relay NC contact
	11	Relay common contact
	12	Relay NO contact

3.5 MODBUS Network Configuration

If your application includes a MODBUS network, make network connections (RS-485 A and RS-485 B) using 18 to 24 AWG shielded twisted pair wires (with 120 ohm characteristic impedance) to terminal block positions 7 and 8 noting inverted B (-) and non-inverted A (+) signal connectors per **Table 3-2**.

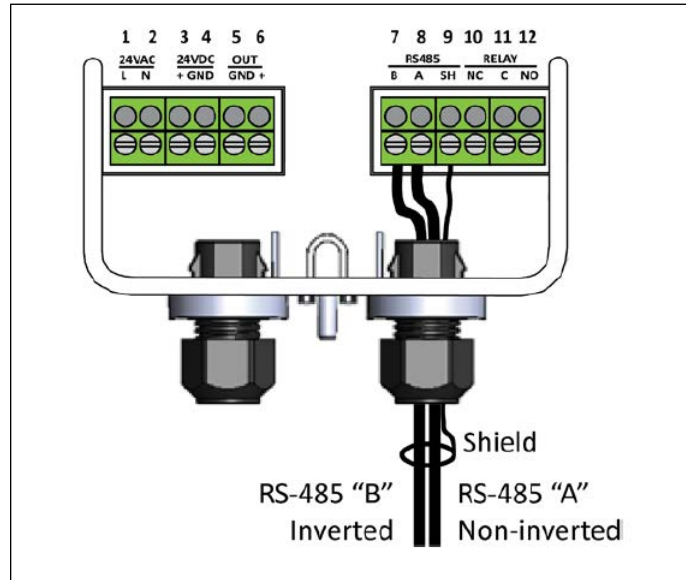

Figure 3-6 - MODBUS Network Wiring

Table 3-2 - MODBUS Network Communications Connections

Function	Pin	Wiring Termination
MODBUS Network Communications	7	RS-485 "B" (inverted)
	8	RS-485 "A" (non-inverted)
	9	RS-485 shield

CAUTION

For MODBUS network communications wiring, use only 18-24 AWG shielded twisted pair wire with 120 ohm characteristic impedance.

CAUTION

Connect the RS-485 cable shield to pin 9 (board ground).

NOTE

Selection of the MODBUS Address and Baud Rate is completed through the gas detector setup menu, described later. No jumpers or hardware switch settings are required to configure the MODBUS communications network. This is done electronically from the front panel display.

NOTE

For MODBUS communications with the MRLDS-250, the default communications parameters are as follows.

- Baud rate = 9600
- Parity = no parity
- Stop bits = 1

Confirm that all devices on the MODBUS communications network (including a Building Management System) are configured similarly.

If the MRLDS-250 is at the end of the RS-485 network, be sure to set the RS-485 terminator on the printed circuit board (PCB) to IN. This applies a terminating resistor to the end of the wires per the requirements of the RS-485 protocol. The terminator should be set to OUT for all other installation conditions.

NOTE

Be sure to enable the termination resistor on the device at each end of the network (See Figure 3-1). This includes the Building Management System (if used).

CAUTION

Care should be exercised when changing the terminator switch. Before powering the gas detector, use a fine pointed device or paper clip to slide the switch position. Do not apply force to the switch or push on the switch with any device. The switch changes position up and down along the access slot direction.

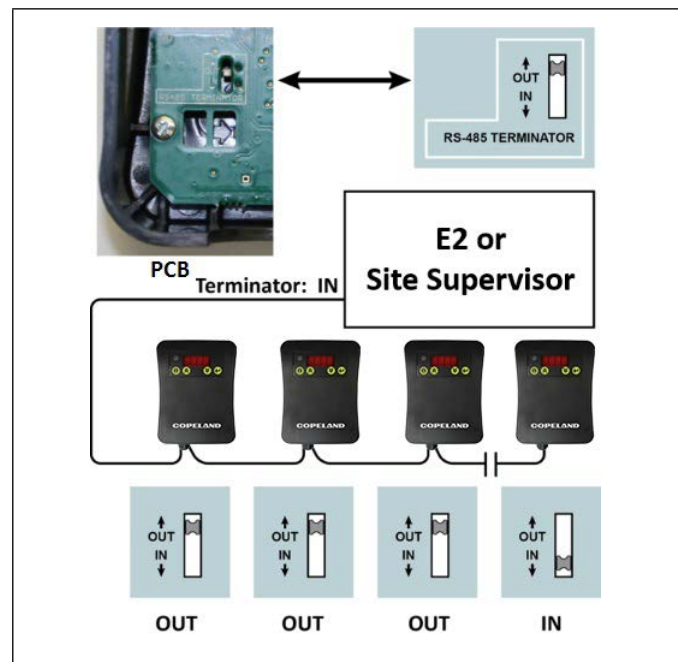

Figure 3-7 - Setting Network Termination Resistors

3.6 Finish Installation

Once the base is mounted and all wiring is complete, align the gas detector housing and press it onto the base. The gas detector will snap into position, completing all electrical connections. Ensure the top and bottom snap locks are engaged.

NOTE

If the right cable gland was not needed during installation and wiring, be sure to install the blanking plug.

CAUTION

Do not apply caulking or other material around the gas detector base. The gas detector relies on air exchange through the spaces between the base and the gas detector housing. Do not obstruct the small gap around the housing and the base with any material.

4 Operation and Stabilization

4.1 Power Up and Warm-up

On powering up, the MRLDS-250 will sense for the presence of gas after an initial warm-up period of two to five minutes. The green LED will flash at a one-second interval during the warm up.

4.2 Stabilization

CAUTION

It is vital when first installing the gas detector that it warms up in an atmosphere that is known not to contain any background concentrations of refrigerant. Copeland offers portable gas detectors for this purpose. Contact Technical Support for more information.

4.3 Perform a Manual Zero

After the gas detector stabilizes, the power LED stops flashing and is lit continuously. Copeland recommends manually zeroing the MRLDS-250 after a 1-hour stabilization period. Increase this stabilization period to 3 hours for freezer applications.

To manually zero the gas detector, press and hold the UP and DOWN buttons simultaneously for 5 seconds. The gas detector will beep and the display will show zero when zeroing is complete. The display will show fAiL if the temperature is changing too quickly or there is an active alarm condition. Additionally, certain system faults (F.-08, F.-10 through 14, and/or F.-16) will prevent a manual zero from being performed.

NOTE

A manual zero should be performed in the environment of operation and at the typical operating temperature.

NOTE

Subsequent manual zeros may be performed, provided the atmosphere around the gas detector is free of all background concentrations of refrigerant. Clean air or nitrogen applied to the calibration port for five minutes may be used to ensure the gas detector is clear of all background gas. Re-zeroing with background refrigerant present will cause the gas detector to report incorrect readings.

4.4 Alarms

The following occurs during an alarm condition:

Table 4-1 - MRLDS-250 Behavior During Alarm Conditions

Item	Behavior During Alarm State
Green LED	On (solid)
Display	On (blinks); reports detected PPM concentration
Audible Alarm	On (if enabled and after programmed delay expires)
Relay Output	Activates (after any programmed delay expires)
Analog Output	Changes proportionally with gas concentration (as configured)
Modbus Registers	Registers indicate the alarm condition, ppm, concentration, etc.

NOTE

The alarm feature includes a 20% deadband to prevent alarm “chatter” if the concentration hovers near the alarm setpoint. Once the alarm has been triggered, it will remain latched until the concentration drops below 80% of the alarm setpoint.

4.5 Gas Detector Faults

4.5.1 Overview

There are two levels of fault monitoring built into the gas detector:

1. Non-critical
2. Critical

4.5.2 Non-Critical Faults

Non-critical faults typically recover by allowing the gas detector surroundings to stabilize, for example, after a defrost cycle. The gas detector continues to monitor its surroundings during non-critical faults, but may report inaccurate readings.

The following occurs when a non-critical fault condition exists.

Table 4-2 - MRLDS-250 Behavior During a Non-Critical Fault

Item	Behavior During Alarm State
Green LED	Off (indicating the gas detector is offline)
Display	Shows the appropriate fault code
Analog Output	4-20 mA output Changes to 2 mA 1- 5V output Changes to 0.5V 2-10V output Changes to 1.0V
Modbus Registers	Modbus registers indicate the fault

4.5.3 Critical Faults

Critical faults may indicate an unrecoverable condition. Please refer to **Section 7, MODBUS Communications** for more information. The following occurs when a critical fault condition exists:

Table 4-3 - MRLDS-250 Behavior During a Critical Fault

Item	Behavior During Alarm State
Green LED	Off (indicating the gas detector is offline)
Display	Shows the appropriate fault code
Analog Output	4-20 mA output Changes to 2 mA 1- 5V output Changes to 0.5V 2-10V output Changes to 1.0V
Modbus Registers	Modbus registers indicate the fault

5 Configure the Gas Detector

5.1 User Interface Overview

The gas detector is configured through the built-in menu system. Once mounting is complete, attach the gas detector to the base and apply power.



Figure 5-1 - The User Interface of the MRLDS-250

The user interface consists of four pushbuttons, a 4-digit LED numeric display, and a power LED. The four buttons allow the gas detector to be adjusted based on a parameter list shown below. Button functions are listed in **Table 5-1**.

Table 5-1 - Button Functionality

Button	Description
	Used to access the parameter list. Used to back up one level without writing to memory when the parameter list is active. Used to mute the audible alarm for the time period configured in parameter P.-12.
	Used to increment the value or parameter displayed.
	Used to decrement the value or parameter displayed.
	When pressed together and held for five seconds, this key combination manually zeros the gas detector.
	Saves the currently displayed parameter to memory.

5.2 Setting Parameters

5.2.1 Overview

Press and hold the information button for five seconds to activate the parameter list:

Each parameter is shown in turn by using the UP or DOWN buttons. The parameter is shown as P.-XX, with XX being the parameter value. Pressing Enter while a parameter is displayed allows the attributes of the parameter to be set. Each Parameter has its own attributes, as shown in the following table. Set the attributes as desired, and then press Enter to save the setting.

5.2.2 Configuration Parameters

Parameter	Description
	<p>Maintenance Mode - Sets gas detector to offline mode for 30 minutes.</p> <ul style="list-style-type: none"> 00 Gas detector is online, with normal response to its surroundings (default). 01 Gas detector is offline, and suppresses all outputs. Display reads oFFL (offline) during 30-minute timeout.
	<p>Alarm Setpoint - Sets desired PPM value (range 75 to 3500 ppm) above which alarm occurs. Use UP or DOWN buttons. For faster "coarse" adjustment, hold either button to sweep through the adjustment range quickly. Default setpoint is 200 ppm.</p>

Parameter	Description
P.-03	<p>Analog Output Type - Selects output type:</p> <ul style="list-style-type: none"> • 00 Selects 0-5V • 01 Selects 1-5V (default) • 02 Selects 0-10V • 03 Selects 2-10V • 04 Selects 4-20 mA
P.-04	<p>Alarm ON Delays - Sets the ON delay time (0-15 minutes) for the alarm output signals (relay, Modbus). The default delay is 0 minutes.</p>
P.-05	<p>Alarm OFF Delays - Sets the OFF delay time for the alarm output signals (relay, Modbus) in minutes (0-15). The default delay is 0 minutes.</p>
P.-06	<p>Relay Contact Behavior (Failsafe Mode) -Sets the default relay power state so that power loss can be detected. The behavior of the relay changes from energizing when an alarm condition occurs (default) to energizing at power up (Failsafe). In both cases the relay changes state when an alarm occurs, failsafe is simply inverted. This allows power failures to be detected as alarms.</p> <ul style="list-style-type: none"> • 00 NO (default mode) • 01 Failsafe mode
P.-07	<p>Relay Latching - Controls the relay latching behavior.</p> <ul style="list-style-type: none"> • 00 OFF (default). Relay does not latch, and resets once the alarm condition is removed. • 01 ON. Relay remains latched; reset by BMS command by pressing and holding the Enter button for five seconds.
P.-08	<p>Audible Alarm - The units have an internal audible alarm. You can disable this, but the default setting is "enabled" in compliance with EN378.</p> <ul style="list-style-type: none"> • 00 OFF • 01 ON (default)
P.-09	<p>Display Mode - The display can be turned on by using this parameter. When set to ON the display never shuts off (all operating modes). When ON the display shows the current gas concentration (or 0 if below the squelch). Note that P.-09 is disabled if P.-19=0.</p> <ul style="list-style-type: none"> • 00 OFF during normal operation when the ppm value is below the alarm setpoint (default) • 01 ON <p>In either case, the display will blink the measured PPM value during an alarm state.</p>
P.-10	<p>RS485 Node Address - Sets the RS485 node address (0001 to 0255)</p>

Parameter	Description
P-11	<p>Gas Groups / Specific Gas Selection - Selects either gas group number for broadband operation or specific gas name for gas-specific mode.</p> <p>Broadband: Select from 4 groups of gases:</p> <ol style="list-style-type: none"> 1. R134a, R404a, R407a R407c, R407f, R427a, R507, R514A HFO1233ZD 2. R448a, R449a, R422a R422d HFO1234YF, and HFO1234Ze, R513a, R452a, R452B 3. R22 (by itself) 4. R32 (by itself). <p>Specific Gas: The actual refrigerant name is shown. Select the appropriate refrigerant.</p> <p>NOTE: Gas-specific detectors are factory calibrated to a single refrigerant using specialized manufacturing equipment. If another refrigerant is selected which differs from the factory calibrated setting, the built in calibration no longer applies. Further improvement in detector accuracy may be gained by applying calibration gas containing the newly selected refrigerant and adjusting the gas detector reading to match (see Parameter P.-17).</p>
P-12	<p>Buzzer Mute Time - Sets a time (0-59 minutes) during which the active buzzer remains muted:</p> <ul style="list-style-type: none"> • after the "I" button is pressed, or • after Modbus register 4000 is set to 0.
P-13	<p>Baud Rate - Sets the baud rate for Modbus (RS-485) communications. 00 9,600 baud (default).</p>
P-14	<p>Stop Bits - Sets the number of stop bits required to match the controlling communications equipment (for example, building management system, etc.).</p> <p>01 1 stop bit (default) 02 2 stop bits</p>
P-15	<p>Parity - Sets Modbus parity option.</p> <p>00 None (default) 01 Odd parity 02 Even parity</p>
P-16	<p>Analog Output Scaling - Allows the user to select the full-scale PPM value that represents maximum analog output (for example, 20 mA) for scaling the analog output. Adjustment range is from 100 PPM to 3500 PPM. Default = 3500 PPM. (The setting cannot be adjusted above 3500.)</p> <p>Use the UP and DOWN buttons to set the desired full scale value. All outputs will be scaled to the indicated full scale value.</p> <p>NOTE: Alarm values are not scaled, but are absolute values. Setting a smaller full scale does not correspondingly scale the alarm setting.</p> <p>NOTE: When the PPM level is greater than the programmed analog output Full Scale PPM (P.-16), the analog output will go to a 10% over range state (indicating that the concentration is too high for the analog output to achieve). For example, for a 1-5V setting the analog output would go to 5.5V, for 4-20 mA it would go to 22 mA and so on.</p>

NOTE

The analog output signal range is from 100 PPM to the default value of 3500 PPM, which is scaled across the actual output range selected by the analog output type parameter P.-03. The upper PPM limit is programmable using analog output scaling parameter P.-16. This parameter sets the full scale PPM value creating a PPM range across which the analog output is scaled. See Figure 5-2 for more details.

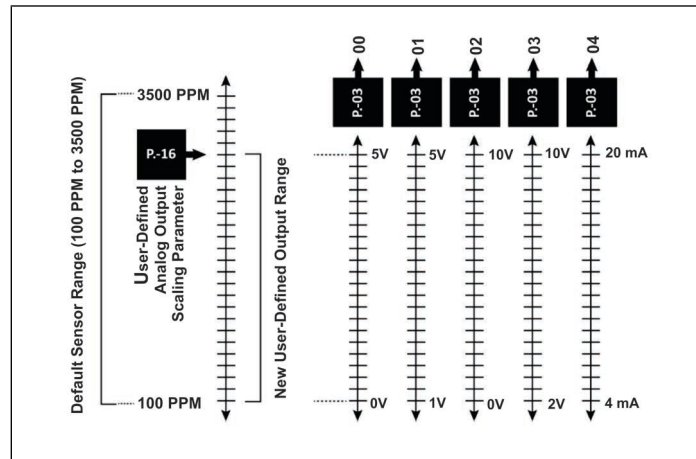





Figure 5-2 - Analog Output Scaling Options

Parameter	Description
P-17	<p>Gas Test Mode - Places the gas detector in gas test mode.</p> <ul style="list-style-type: none"> • 00 Disabled (default) • 01 Enabled <p>When enabled, the display continuously cycles through the following:</p> <ul style="list-style-type: none"> • CAL is displayed briefly. • Next, the gas group number or gas type (based on product code) is displayed. • Then four dashes (---) are displayed. <p>After gas is applied and the 75 PPM squelch level is exceeded, the live concentration replaces the four dashes.</p> <p>See Section 6.4, Adjustment Using Calibration Gas if using Gas Test Mode to initiate the calibration procedure.</p> <p>NOTE: To prevent false alarms, all outputs are suspended while Test Mode is active. The only live indication is the 4-digit display.</p> <p>Once the gas test mode is enabled to perform a gas test or calibration, the unit will automatically go offline for a 10- minute period after the parameter list is exited. (This allows time for the test gas to clear before the unit becomes active).</p> <p>If no activity occurs for ten minutes, the unit exits the Gas Test Mode.</p>

Parameter	Description
	<p>Diagnostics Menu -Parameter 18 provides access to the self diagnostic information. The LED display shows DIAG until the Enter button is pressed. Use the UP and DOWN buttons to scroll through the list of diagnostic attributes.</p> <ul style="list-style-type: none"> A.-01 Current fault condition A.-02 Last fault A.-03 Days in service A.-04 Days since last adjust/test A.-05-A.-07 Factory Use Only A.-08 Detector temperature in °C A.-09 Temperature rate of change A.-10-A.-17 Factory Use Only <p>To aid in troubleshooting, the operator may choose to reset the gas detector to its default state by holding both the UP and DOWN buttons for 5 seconds while in the Diagnostics Menu. All settings, including the alarm setpoint, gas adjustments, the selected gas curve, calibration data, the Modbus address, etc. revert to specific default values after a reset.</p> <p>IMPORTANT: Calibrations on either gas-specific or broadband models are lost after a reset. This returns the gas detector to an uncalibrated condition. See parameter P.-17 for information on how to recalibrate the gas detector.</p> <p>See Section 9, Replacement Parts and Accessories for a complete list of codes and details on the reset option.</p> <p>If no activity occurs for ten minutes, the unit exits the Gas Test Mode.</p>
	<p>Response Filtering - This parameter is used to turn filtered output ON (01) or OFF (00). The default setting is ON (01). The Modbus and analog output are filtered so that responses below 75 ppm are squelched. If the display mode (P.-09) is set to ON (01) the display shows 0 for any signal level below 75 ppm. Some installations may wish to monitor the small analog output changes that may be created by the detector environment. Turning filtering OFF (00) allows these small variations around the minimum analog output (for example, 4 mA, 1V, etc.) to be transmitted via Modbus and the analog output terminals.</p> <p>NOTE: The detector display is OFF when filtering is OFF (P.-09 is disabled).</p> <p>NOTE: Whenever filtering is OFF the detector display will turn ON for 10 minutes if the detector is re-zeroed (see Section 4.3, Perform a Manual Zero). This is intended to aid maintenance testing. The analog outputs continue to transmit the full, unfiltered range, and the alarm setpoint remains active.</p> <p>NOTE: If filtering is turned off (00), Analog Output Scaling (P.-16) should be adjusted to 500 ppm.</p>

5.3 Completing Setup

To complete the setup after all parameters are set as needed, simply press and hold the information button  for 5 seconds to exit the Parameter list: The gas detector is now actively monitoring its surroundings.

NOTE If no buttons are pressed for two minutes, the MRLDS-250 exits setup mode automatically.

6 Functional Tests and Adjustments

6.1 Introduction

To comply with the requirements of EN378 and the European F-GAS regulation, gas detectors must be tested annually. However, local regulations may specify the nature and frequency of this test.

CAUTION Check local regulations on calibration or testing requirements.

CAUTION The MRLDS-250 contains sensitive electronic components that can be easily damaged. Do not touch or disturb any of these components.

WARNING Annual checks and adjustment using calibration gas is recommended. Calibration gas adjustment frequency may be extended based on application, but should never exceed a time period of two years.

WARNING In applications where life safety is critical, calibration gas adjustment should be completed quarterly (every three months) or on a more frequent basis. Copeland is not responsible for setting safety practices and policies. Safe work procedures including calibration policies are best determined by company policy, industry standards, and local codes.

WARNING Failure to test or adjust the unit in accordance with applicable instructions and with industry guidelines may result in serious injury or death. The manufacturer is not liable for any loss, injury, or damage arising from improper testing, incorrect adjustment, or inappropriate use of the unit.

WARNING Before testing the gas detectors on-site, the MRLDS-250 must be powered up and allowed to stabilize.

WARNING After initial installation, the MRLDS-250 should be gas tested to ensure proper operation.

WARNING The testing and/or adjustment of the unit must be carried out by a suitably qualified technician, and must be completed:

- In accordance with this manual.
- In compliance with locally applicable guidelines and regulations.

Suitably qualified operators of the unit should be aware of the regulations and standards set down by the industry/country for the testing or calibration of this unit. This manual is only intended as a guide and, insofar as permitted by law, Copeland accepts no responsibility for the calibration, testing, or operation of this unit.

The frequency and nature of testing or calibration may be determined by local regulation or standards.

EN378 and the F-GAS Regulation require an annual check in accordance with the manufacturer's recommendation.

6.2 Bump Testing vs. Adjusting Detector Response

There are two concepts that need to be differentiated:

- Bump test.
- Gas detector response adjustment.

A bump test exposes the gas detector to a gas. The operator then observes the gas detector's response to the gas. The objectives are two-fold:

- Establishes if the gas detector is reacting to the gas.
- Determines if all of the detector outputs are working correctly.

There are two types of bump test:

- Quantified: A known concentration of gas is used.
- Non-quantified: A gas of unknown concentration is used.

Adjusting gas detector response exposes the gas detector to a calibration gas as well (like a quantified bump test), but additionally sets the actual gas detector response level (via parameter P.-17) to ensure that the gas detector activates at the specified gas concentration.

Refer to the following sections for addition information on bump testing and gas detector response adjustment.

CAUTION

Before you carry out the test or adjustment:

- Advise occupants, plant operators, and supervisors.
- Check if the gas detector is connected to external systems such as sprinkler systems, plant shut down, external sirens and beacons, ventilation, etc., and disconnect as instructed by the customer.
- For bump test or calibration, the MRLDS-250 should be powered up and fully stabilized (see Section 4, Operation and Stabilization).

6.3 Bump Testing

WARNING

Notify others that testing is underway. During bump testing, the alarm outputs are active and will trigger the intended response. It is the operator's responsibility to ensure that such actions are acceptable and can be performed safely.

After installation and parameter setup (see **Section 5, Configure the Gas Detector**), the units should be bump tested. Expose the gas detector to test gas. The gas selected should be a high enough concentration to put the system into alarm and light the LED display.

With a bump test you can see the functions of the gas detector:

The LED display will light and show the detected PPM concentration once the alarm setpoint is reached.

The relay and audible alarm will function as configured including any delays set (ON or OFF).

The output (0-10V, for example) will show the gas level.

Ideally, bump tests are conducted on-site in a clean air atmosphere.

Table 6-1 - Bump Testing Using Calibration Gas Cylinders

Step	Bump Testing Using Calibration Gas Cylinders
1	Remove the Splash Guard accessory if one is used.
2	Connect the regulator to the test gas port using 3 mm or 1/8" inside diameter tubing (see below).
3	Expose the gas detector to gas from the cylinder. Monitor the LED display reading. Refer to the Section 1.5, Specifications for acceptance criteria.

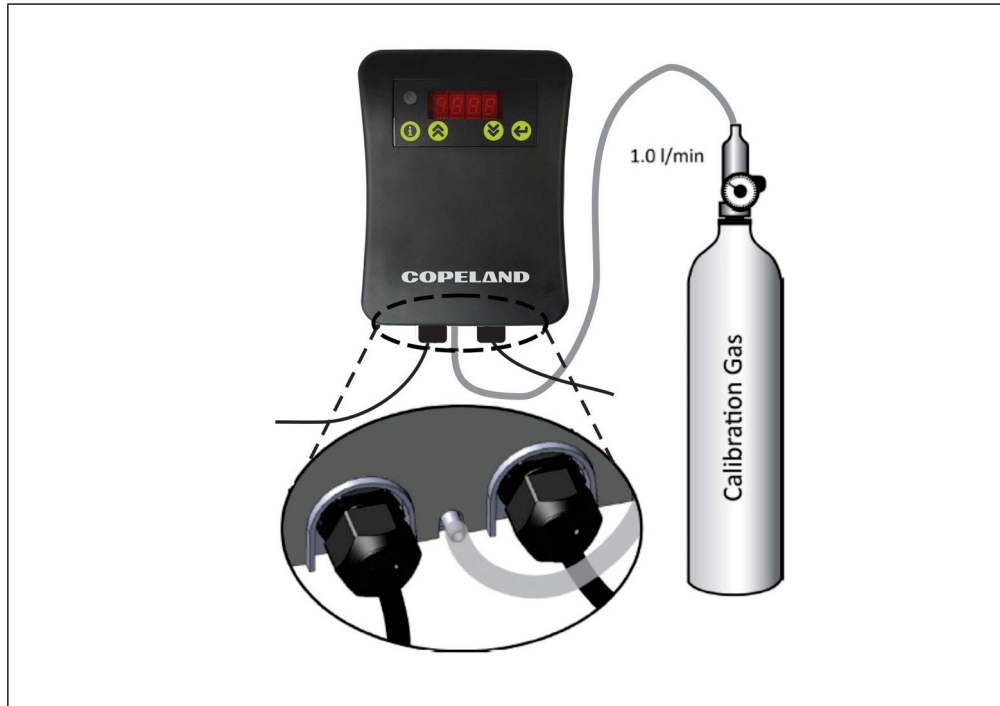

Figure 6-1 - Using Calibration Gas

6.4 Adjustment Using Calibration Gas

Adjustment Using Calibration Gas requires a gas cylinder with the appropriate gas and concentration.

Note that a calibration kit if offered that consists of a calibration gas cylinder and a flow regulation valve with flexible non-absorbent tubing.

NOTE

For improved accuracy and response, the gas detector should be protected from excess drafts while performing the adjustment. Excess air circulation may dilute the applied calibration gas and lead to a lower than expected response.

Table 6-2 - Bump Testing

Step	Adjustment Using Calibration Gas Cylinders
1	Connect the regulator to the test gas port using 3 mm or 1/8" inside diameter tubing.
	<p>Enable parameter P.-17 Gas Test Mode (see Section 5, Configure the Gas Detector). When enabled, the display continuously cycles through the following:</p> <p>CAL is displayed briefly.</p> <p>Next, the gas group number or gas type (based on product code) is displayed.</p> <p>Then four dashes (----) are displayed.</p> <p>After gas is applied and the 75 PPM squelch level is exceeded, the live concentration replaces the four dashes.</p> <p>NOTE: The analog outputs, relay activity, and RS-485 ppm reporting are suspended in Gas Test Mode to prevent false alarms.</p>
3	Expose the gas detector to gas from the cylinder. Monitor the 4-digit LED display reading.
4	Wait for the PPM reading to stabilize. This should take approximately 4-6 minutes. Minor changes (less than 5 PPM in 10 seconds) are considered stable readings. Compare the response value with the calibration gas concentration.
5	Adjust the gas detector displayed value by using the UP or DOWN buttons to increase or decrease the value shown. Adjust until the reading is within $\pm 2\%$ of the calibration gas. For example, if the calibration gas is 1000 PPM, the gas detector is adjusted properly when the displayed reading is between 980 and 1020 PPM.
6	Press the Enter button to store the new adjustment. Turn off the calibration gas and remove the tubing from the calibration port. If no further changes to the other Parameters are required, press and hold the information button for 5 seconds to exit the Parameter list.
7	If no further changes to the other parameters are required, press and hold the  button for 5 seconds to exit the Parameter list. Upon exiting the parameters list, the gas detector will enter offline mode for a period of 10 minutes. This allows time for the calibration gas to dissipate after testing. During offline mode, the gas detector suppresses all outputs. The display reads oFFL (offline) during 10-minute timeout.

NOTE All calibration gas mixtures have a blend tolerance. The tolerance will limit the actual adjustment accuracy that is achievable.

7 MODBUS Communications

7.1 Introduction

The MRLDS-250 gas detector can be configured to communicate on an RS-485 network using MODBUS-RTU protocol. Before configuring the gas detector for MODBUS communications, be sure your network connection is complete and your network termination switches are set appropriately. Refer to **Section 3, Wiring and Configuration** for details.

7.2 Communications Settings

There are 255 selections available to be set electronically, from addresses 1 to 255 inclusive. MODBUS data with a zero in the address field is received by all detectors (regardless of the address selected) to enable the master device to broadcast simultaneously to all the detectors.

Refer to the specifications section for information on RS-485 network communications parameters such as data bits, stop bits, and more.

7.3 Analog Input Registers

Analog input registers are read only and use function code 04.

Table 7-1 - Analog Input Registers

Reg	Description	Range	Units	P.-##
1000	Concentration gas level	0-100	%FS	--
1001	Concentration gas level	0-65, 535	PPM	--
1002	Reserved			--
1003	Full scale detector level	0-65, 535	PPM	--
1004	Alarm setpoint (% full scale)	0-100	%	--
1005	Gas detector timer	0-65, 535	hours	--
1006	Node address	1-247	none	P.-10
1007	Software version		none	--
1008	Reserved			--
1009	Reserved			--
1010	Reserved			--
1011	Reserved			--
1012	16-bit fault code	0-65535	none	--

7.4 Analog Output Registers

Analog output registers are readable (using function code 03) and writable (using function code 06).

Table 7-2 - Analog Output Registers

Reg	Description	Range	Units	P.-##
2000	Alarm setpoint	75-3500	PPM	P.-02
2001	Alarm ON delay (Alarm flag register 3000 is set to 1)	0-15	min	P.-04
2002	Buzzer mute time	0-59	min	P.-12
2003	Alarm OFF delay	0-15	min	P.-05
2004	Relay action	0=NO 1=Fail-safe	none	P.-06
2005	Relay latching enable	0=Disable 1=Enable	none	P.-07
2006	Buzzer enable	0=Disable 1=Enable	none	P.-08
2007	Display mode	0=Off 1=On	none	P.-09
2008	Analog output type	0=0-5 V 1=1-4 V 2=0-10 V 3=2-10 V 4=4-20 ma	none	P.-03
2009	Baud rate	0=9600 1=19200	none	P.-13
2010	Stop bits	1 or 2	none	P.-14
2011	Gas curve number	1 to 4 (broadband unit) or gas type (gas specific)	none	P.-11
2012	Analog output full scale PPM (R/O)	100-3500	PPM	P.-16
2013	Parity	0=None 1=Odd 2=Even	none	P.-15

7.5 Input Status Flags

Input Status Flags are readable (using function code 02).

Table 7-3 - Input Status Flags

Reg	Description	Range	P.##
3000	Alarm flag (0 or 1=Alarm)	0-1	--
3001	Relay state (0 or 1=energized)	0-1	--
3002	Detector fault (0 or 1=fault)	0-1	--
3003	Red LED state (0 or 1=ON)	0-1	--
3004	Green LED state (0 or 1=powered on)	0-1	--
3005	Reserved		--
3006	Start up (0=normal operation, 1=warming up)	0-1	--
3007	Reserved		--
3008	Reserved		--

7.6 Output Status Flags

Output Status Flags are readable (using function code 01) and writable (using function code 05).

Table 7-4 - Output Status Flags

Reg	Description	Range	P.##
4000	Buzzer flag (0 or 1=ON)	0=Off 1=On	--
4001	Test required (If operating for > 1 year). (1=requires testing)	0=Okay 1=Test	--

8 Troubleshooting

8.1 Fault Codes

To comply with the requirements of EN378 and the European F-GAS regulation, gas detectors must be tested annually. However, local regulations may specify the nature and frequency of this test.

The MRLDS-250 features sophisticated internal status monitoring and will indicate whether a fault condition exists on the front display (F.-XX, with XX being the fault number).

There are two classes of fault conditions: critical and non-critical. In general, non-critical faults occur when environmental conditions exist that are outside the product's specified operating range, or if an installation error has occurred (for example, incorrect wiring).

The gas detector will typically continue to monitor its surroundings (except for fault F.-08), and may report inaccurate readings and false alarms.

Correcting non-critical faults is a matter of waiting for the environmental conditions to return to a more typical condition, correcting wiring mistakes, or in some cases, relocating the gas detector. For example, placing the gas detector near a forced air heater may cause temperature faults. The non-critical fault range is F.-01 to F.-08.

Critical faults indicate a functional problem that results in the gas detector no longer monitoring its surroundings for refrigerant.

The fault number is displayed and the power LED is turned off, indicating that the gas detector is offline. The critical fault range is F.-09 to F.-16. *If any of these faults occur, first try to clear the faults by cycling power to the sensor. The easiest way to do this is by removing the sensor from the base and reattaching.* If the fault returns after cycling power, the gas detector should be removed from service and replaced.

Additionally, the faults are stored as a hex number and can be accessed in the Diagnostics menu P.-18. The associated hex codes are listed next to the Fault Code in (Table 8-1). Refer to Diagnostics Menu P.-18 in **Section 8.2, Diagnostic Attributes (P.-18)** for additional information.

Table 8-1 - Fault Codes

Description	Fault Code	Hex Code	Possible Causes
Gas Detector Temperature Fault	F.-01	0x0001	Gas Detector temperature reports > 55°C or < -35°C.
Gas Detector Temperature Rate of Change Fault	F.-02	0x0002	Temperature rate of change exceeds ~1°C/min for more than 15minutes.
RS485 RX Fault	F.-03	0x0004	Message too long for receive buffer.
RS485 CRC Fault	F.-04	0X0008	Transmission is corrupted (computed CRC doesn't match transmitted CRC).
Open Loop Fault	F.-05	0x0010	Possible wiring, connection, and/or termination issue exists. When analog output type is 4-20ma and loop is open, use 18-24AWG shielded twisted pair with 120 ohm characteristic impedance for Modbus connections.
MODBUS Fault	F.-06	0x0020	MODBUS message was truncated or timed out early.

Table 8-1 - Fault Codes

Description	Fault Code	Hex Code	Possible Causes
PPM Overrange Fault	F-07	0x0040	PPM exceeds 9999. This may indicate a gross (very large) leak. If no leak is present, it indicates a gas detector error.
Input Voltage Fault	F-08	0x0080	Input supply power to the MRLDS-250 is out of range (i.e., 24V ±20%). IMPORTANT: If this fault is active, the gas detector is offline and not monitoring. Correct the input supply voltage to restore normal operation.
Critical Faults	F-09		Critical fault. Cycle power to the sensor and see if the fault clears. If not, contact Copeland technical support for additional guidance.
	:	:	
	F-15		

IMPORTANT: Fault F.-15 may be caused by rapid changes in temperature and other environmental effects. If the F.-15 fault remains after the ambient temperature has stabilized, perform a manual re-zero to clear the fault. See Section 4.3, Perform a Manual Zero.

8.2 Diagnostic Attributes (P.-18)

Use this option to review the built-in diagnostic attributes. Access the parameter list (see Section 5, Configure the Gas Detector) and select P.-18. Press the Enter button to access the diagnostics, and then use the UP or DOWN button to select each attribute. The following information is available.

Table 8-2 - Diagnostics Attributes

Attribute	Description
R-01	Displays the current fault condition code in hex format: 0000 = no faults are active XXXX = HEX number See Table 8-1 for the HEX format cross reference.
R-02	Displays a hex format code that corresponds to any faults that occurred since the internal fault record was last erased. See Table 8-1 for the HEX format cross reference. The records may be erased by pressing the ENTER button.
R-03	Displays the number of days that the MRLDS-250 has been in service. The value of this attribute rolls over after 9999.
R-04	Displays the elapsed time (in days) from the last gas adjustment or test. This value is automatically reset to 0000 after completing a gas adjustment via Test Mode P.-17. (Note that the new adjustment is stored using the Enter button.) The value may be reset to 0000 by pressing the ENTER button.

Table 8-2 - Diagnostics Attributes

Attribute	Description
R-05	Reserved
:	
R-07	
R-08	Displays the sensor temperature in °C.
R-09	Displays the sensor's approximate rate of temperature change per half minute interval (°C change over 30 seconds).
R-10	Reserved
:	
R-17	

8.3 Resetting the MRLDS-250 to Default Values

The gas detector may be reset to its default state, if needed, to aid in troubleshooting. All settings, including alarm setpoint, gas adjustments, selected gas curve, calibration data, Modbus address, etc. revert to specific default values after a reset. The broadband sensor option (P/N 809-0030) resets to gas group 1. Gas specific products (P/Ns 809-0031 to 809-0044) are reset to the R134a gas curve.

NOTE: Calibrations on either gas-specific or broadband models are lost after a reset. This returns the gas detector to an uncalibrated condition. See parameter P.-17 for information on how to recalibrate the gas detector.

NOTE Before performing this operation, it is advisable to write down all the parameter settings so they can be re-programmed.

Table 8-3 - Resetting MRLDS-250 to Default Values

Step	Description
1	Access diagnostics menu P.-18.
2	Press and hold both the UP and DOWN buttons for 5 seconds. This will cause the following to occur: <ul style="list-style-type: none"> • All the LED segments will then light for 3 seconds. • The gas detector resets to the default settings. • The gas detector beeper sounds for 3 seconds.
3	After 3 seconds, the user is returned to the parameter list at parameter P.-18.
4	The gas detector may now be re-programmed for further troubleshooting if needed.

8.4 Other Symptoms

Other common wiring problems can also cause the gas detector to malfunction. Check below for additional conditions that will cause gas detector issues.

Table 8-4 - Other Symptoms and Possible Causes

Symptom	Possible Cause(s)
Green power LED off	Check power supply. Check Wiring.
Alarms in the absence of a leak	If you experience alarms in the absence of a leak, try setting an alarm delay. Perform a bump test to ensure proper operation.

9 Replacement Parts and Accessories

The following items are available as replacement parts:

NOTE

All modules come ready to mount to the original mounting base provided.

Table 9-1 - Replacement Parts and Accessories

Part Number	Description
809-0030	Gas Detector Module, Broadband, 0-3, 500ppm
809-0031	Gas Detector Module, Calibrated to R2, 5%
809-0034	Gas Detector Module, Calibrated to R404A, 5%
809-0035	Gas Detector Module, Calibrated to R407A, 3%
809-0036	Gas Detector Module, Calibrated to R407C, 3%
809-0037	Gas Detector Module, Calibrated to R407F, 3%
809-0038	Gas Detector Module, Calibrated to R410A, 3%
809-0039	Gas Detector Module, Calibrated to R422A, 5%
809-0040	Gas Detector Module, Calibrated to R422D, 5%
809-0041	Gas Detector Module, Calibrated to R448A, 5%
809-0042	Gas Detector Module, Calibrated to R449A, 5%
809-0043	Gas Detector Module, Calibrated to R513A, 5%
890-0044	Gas Detector Module, Calibrated to R507, 5%
603-1100	Splash Guard Kit (Accessory): Provides additional protection for wash down or impact. Includes mounting hardware for attaching to walls. NOTE: The gas detector response time will lengthen when the Splash Guard is used. The installer is responsible for determining whether the response time is suitable for the application.
026-1315	Installation and Operation Manual

Appendix: E2 Setup

The Modular Refrigeration Leak Detection Sensor is Copeland's state-of-the-art infrared refrigerant gas detector that can detect a wide range of gases. The MRLDS-250 can be used on a stand-alone basis or integrated into supervisory controls. The MRLDS-250 can be used in locations that require continuous monitoring and to add gas detection solutions to an existing system.

The MRLDS-250 is available in two versions:

- The broadband gas detector is used as a general purpose gross leak detector and is factory tested and certified to +/- 35% accuracy.
- The gas specific versions come factory certified and calibrated with +/- 3% accuracy to the target refrigerant when there is a need for more accurate detection.

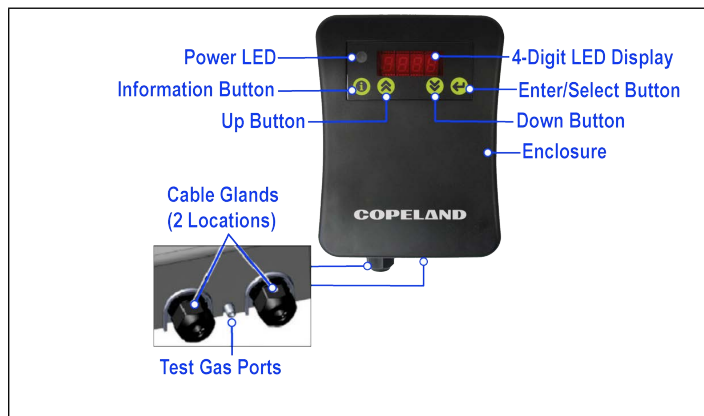

Figure A-1 - MRLDS-250 Components

For complete part number and installation information, see the full MRLDS-250 manual (P/N 026-1315).

MRLDS-250 Installation

Mounting the MRLDS-250

1. To open the housing as received, use a flat blade screwdriver and depress the top latch. While pushing the latch, grasp the back edge of the housing near the latch and pull the back away.
1. Position the base to the pre-determined mounting location.
2. For Wall Mount, attach the MRLDS-250 base to the mounting surface using two #6 screws (provided) through two of the seven mounting holes (see **Figure A-2**). For Junction Box Mount, attach the MRLDS-250 base to the junction box through the two junction box holes.

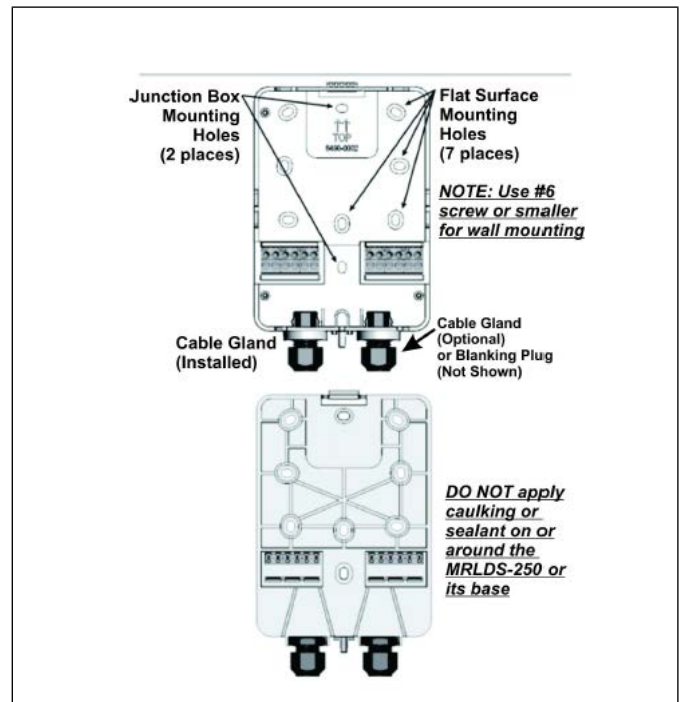

Figure A-2 - Front and Back of the MRLDS-250 Base

Wiring and Configuration

Either 24VAC or 24VDC may be used to power the MRLDS-250. Connect wiring to the appropriate terminal locations. Use two wires, between 14 and 22 AWG. Refer to **Figure A-3** for AC wiring (left) or DC wiring (right):

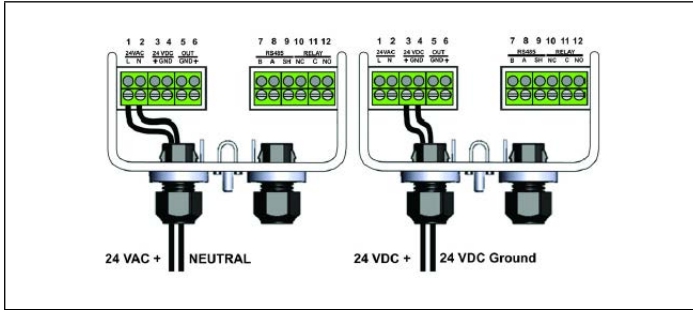

Figure A-3 - Supply and Power Wiring Options

WARNING: The MRLDS-250 must be powered by:

- A suitable UL 60950/CSA certified power supply that is isolated from line voltage by double insulation.
- An appropriately rated UL listed/CA Class 2 Transformer; a 10VA Transformer is recommended.
- For multiple devices cascaded, a 50VA Class 2 Transformer is recommended and neutral polarity **MUST** be maintained across units.

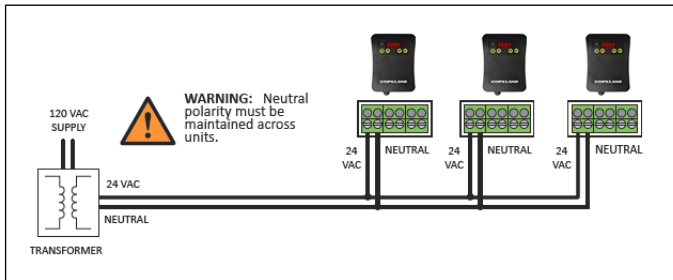

Figure A-4 - Power Wiring of a Device Network

The MRLDS-250 provides an analog output signal that is proportional to the level of gas detected. Connect two 18 to 20 AWG wires to terminal block positions 5 and 6 (see **Figure A-5a**), noting ground and signal polarity.

Make relay connections (NO, NC, or both) using 18 to 20 AWG wires to terminal block positions 10, 11, and 12 (see **Figure A-5b**), noting normally open, normally closed, and common connectors.

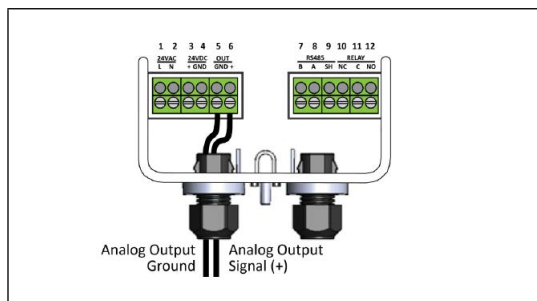

Figure A-5a - Analog Output Wiring

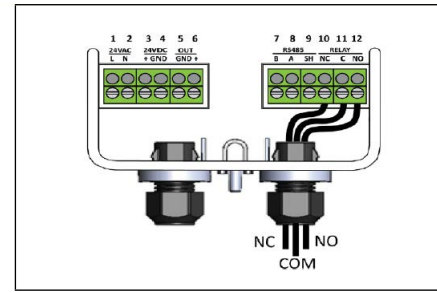

Figure A-5b - Sample Relay Output Wiring

MODBUS Network Configuration

NOTE: For MODBUS network communications wiring, use only 18-24 AWG shielded twisted pair wire with 120 ohm characteristic impedance.

When connecting MRLDS-250 to an E2 or Site Supervisor via MODBUS, make network connections (RS-485 A and RS-485 B) using 18 to 24 AWG shielded twisted pair wires to terminal block positions 7 and 8 as shown in **Figure A-6**.

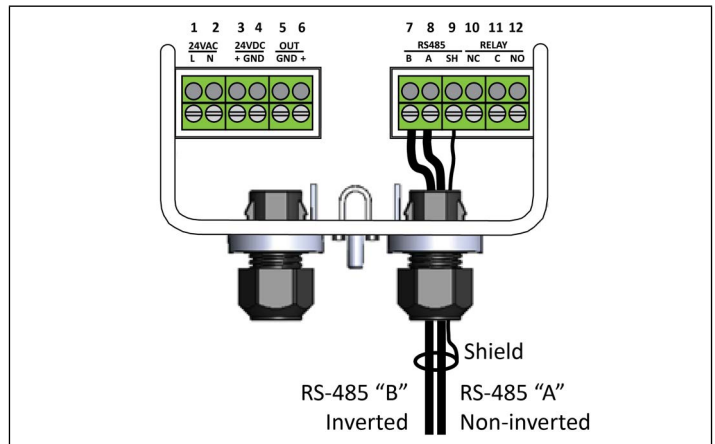

Figure A-6 - MODBUS Network Configuration

For MODBUS communications with the MRLDS-250, the default communications parameters are as follows:

- Baud rate = 9600
- Parity = none
- Stop bits = 1

If the MRLDS-250 is at the end of an RS-485 network, be sure to set the RS-485 Terminator on the inside of the cover panel PCB, to IN. When set to IN, a terminating resistor is applied to the end of the line. The terminator should be set to OUT for all other installation conditions as shown in **Figure A-7**.

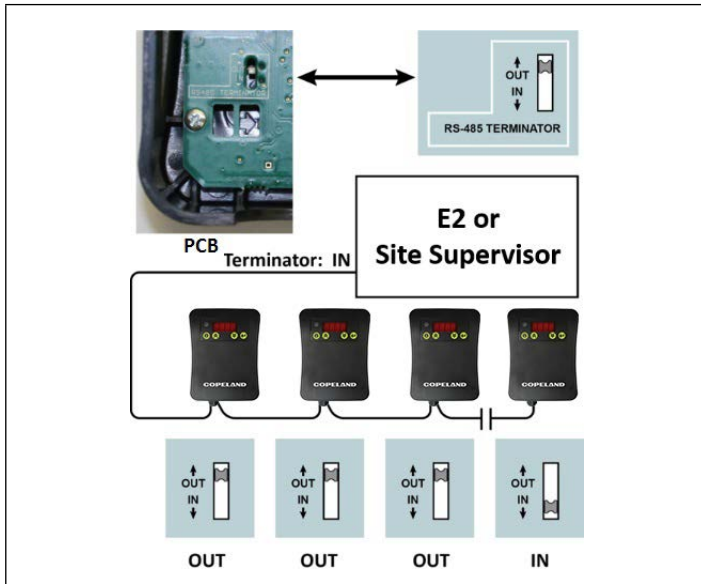

Figure A-7 - RS-485 Termination Resistor Setting

Set Up Analog Output Type and Scaling

- For Analog Output, look for **P.-03** on the parameter list then press the Enter button.
- Set the desired output by pressing Up or Down to select the type designated as follows:
 - 00 selects 0-5V
 - 01 selects 1-5V (Default)
 - 02 selects 0-10V
 - 03 selects 2-10V
 - 04 selects 4-20mA
- Press the Enter button to save.
- For Scaling, look for **P.-16** on the parameter list then press the Enter button.
- This will allow you to select the full scale PPM value that represents the maximum analog output (for example: 1000PPM = 5V when 1-5V output range was selected for P.-03). Use Up or Down to adjust the value and set it to 1000PPM.
- Press the Enter button to save the setting.

MRLDS-250 Modbus Setup

Setting Up Modbus Address and Baud Rate

- Press and hold the information button for five seconds to activate the parameter list.
- For the Address, look for **P.-10** on the parameter list then press the Enter button.
- Set the desired address by pressing Up or Down and press the Enter button to save.
- For the Baud Rate, look for the **P.-13** parameter then press the Enter button.
- Select **00** for 9600 Baud or **01** for 19200 Baud. Press the Enter button to save.

How to Add an MRLDS-250 to the E2 Controller

- MRLDS-250 is only native and licensed for up to 15 devices on E2 Controllers with firmware version 4.09 and above; otherwise you must add a description file and License Key.
 - Contact Customer Service to obtain the License Key: **P/N 527-0476**.
 - Phone Number: 770-425-2724 Option 4
 - Email: ColdChain.CustomerService@copeland.com
 - Add the description file using UltraSite.
 - Reboot the controller after the upload.
 - Load the License Key on the E2 by logging in and then press , , , .
 - Press **F1** for **ADD FEATURE** and enter the **License Key**.
 - Add the MRLDS-250 by pressing , , , to access **Connected I/O Boards and Controllers**.
 - Press **F2** to select **C4: Third Party tab**.
 - Scroll down to MRLDS-250 and enter the quantity of MRLDS-250 devices up to the maximum indicated.
 - Press the button to save.
 - Press , , , for Network Summary or .
 - Scroll down to the MRLDS-250 and press **F4** to **COMMISSION**. Repeat for each MRLDS-250 added.
 - Select the address the MRLDS-250 is set to and press to confirm.
 - The MRLDS-250 should be **Online** on the E2 Network Summary (press .

How to Configure Alarm Setup on the E2 Controller

1. Press **Menu**, **8** and then select **MRLDS-250**.
2. Press **F5** for **SETUP** and **F2** to select **C2: Set Points**.
3. Set the parameters depending on the System Requirement and press the **Save** button to save.

MRLDS to MultiFlex I/O

How to Set a MultiFlex Input Point

An input point on a MultiFlex board consists of two terminals. One of these terminals labeled as **SIG** reads the signal from the sensor, while the other, labeled **0v** is where the sensor ground wire is connected:

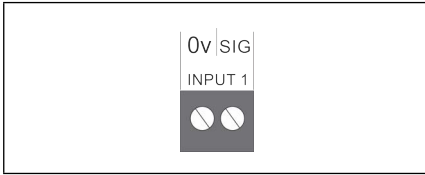

Figure A-8- MultiFlex Input Point

The Analog Output Signal(+) should go to (**SIG**) terminal of the MultiFlex board and the Ground (**GND**) should go to (**0v**) terminal of the board.

The DIP switch setting of the MultiFlex board terminal for the MRLDS-250 should be in the **OFF** position (see **Figure A-9**) because it supplies its own voltage signal to the point:

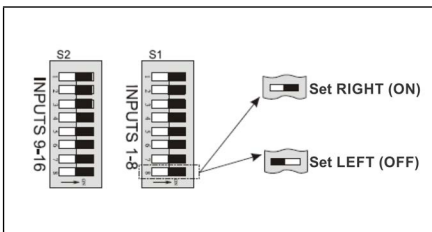

Figure A-9 - MultiFlex Input Dip Switches

How to Set the Input Type on the E2 Controller

1. Press **Menu**, **8**, **1** to go to the **Input Status** Screen.
1. Select the input point where the MRLDS-250 is connected, and press **F1** for **SETUP**. Press **1** for the Analog.
2. Highlight **Sensor Type** and press **F4** for **LOOK UP**. Select Linear and press **Enter** to confirm.
3. Navigate down to Eng Units and press **F4** for **LOOK UP**. Select **PPM 33** and press **Enter** to confirm.
4. Set the **Low End Point** and **HighEnd Point** equivalent to the range set on **P-.03** for Analog Output.
5. Set the **Low End EU** and the **High End EU** equivalent to PPM Scaling set on **P.-16**
6. For the **Low End Limit**, set it to **-10%** of Low End EU and for the **HighEnd Limit**, set it to **+10%** of High End EU.
7. Press the **Save** button to save.

*For more product information,
scan the QR Code:*



Visit our website at copeland.com/en-us/products/controls-monitoring-systems for the latest technical documentation and updates.
For Technical Support call **833-409-7505** or email ColdChain.TechnicalServices@Copeland.com

The contents of this publication are presented for informational purposes only and they are not to be construed as warranties or guarantees, express or implied, regarding the products or services described herein or their use or applicability. Copeland reserves the right to modify the designs or specifications of such products at any time without notice. Responsibility for proper selection, use and maintenance of any product remains solely with the purchaser and end-user.
©2024 Copeland is a trademark of Copeland LP.